

Signal Conditioning & *Communication Interfaces* *Product Catalog*

PERFORMANCE
MADE
SMARTER



TEMPERATURE | I.S. INTERFACES | COMMUNICATION INTERFACES | MULTIFUNCTIONAL | ISOLATION | DISPLAY

PR
electronics

Our purpose

is to create market-leading site standard solutions with high signal integrity and simplicity for our customers, concentrating on innovation in six core business areas: Temperature, I.S. Interfaces, Communication Interfaces, Multifunctional, Isolation and Display.

Our products are individually outstanding, but when our point-to-point temperature measurement devices, I.S. interfaces, backplanes, multifunctional signal devices and future-proof communication interfaces are combined, our solutions are truly unrivalled.

We will be

our customer's trusted partner for the best and most innovative signal conditioning solutions in the process and factory automation industries.

We provide

a wide range of benefits to our customers through innovative solutions and close collaboration:

- The highest signal integrity from your measurement point to control system
- Maximum uptime based on our Install and Forget® philosophy
- Easy and cost-effective deployment and monitoring with intuitive communication interfaces
- Site standard devices that are easily programmable to suit your specific application
- Day-to-day delivery

Since 1974, we have been dedicated to perfecting our core competence of innovating high precision technology with low power consumption. With a dedicated R&D center that is integrated with our lean production facility at our headquarters in Denmark, we are today one of the leading companies within signal conditioning.

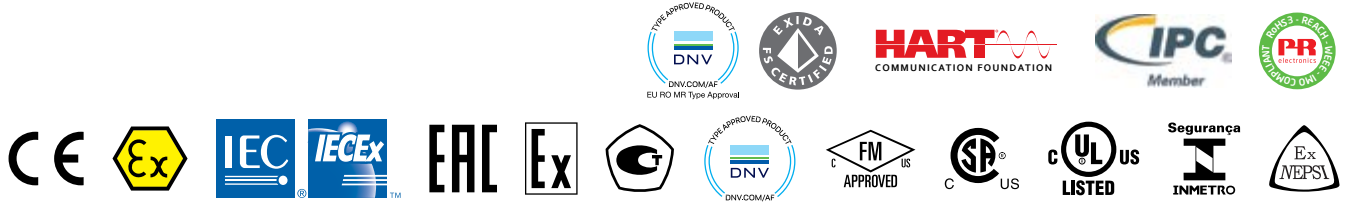

MULTIFUNCTIONAL TRANSMITTERS

3114 - 4104 - 4114 - 4116 - 4131 - 4179 - 4184..... 4-5
 5114A - 5115A - 5116A - 5131A - 9116A..... 6

FREQUENCY / PULSE

3225 - 4222 - 4225..... 7
 5202A - 5223A - 5225 - 9202A..... 8

ISOLATORS

3103 - 3104 - 3105 - 3108 - 3109..... 9
 3117 - 3118 - 3185 - 3186..... 10
 5104A - 5106A - 6185..... 11
 9106A - 9107A - 9203A..... 12

TEMPERATURE TRANSMITTERS

3101 - 3102 - 3111 - 3112 - 3113..... 13
 3331 - 3333 - 3337..... 14
 5331A - 5332A - 5333A - 5334A..... 15
 5335A - 5337A - 5343A - 5437A..... 16
 6331A - 6333A - 6334A - 6335A - 6337A..... 17
 6437A - 7501 - 9113A..... 18

I.S. TEMPERATURE TRANSMITTERS

5331D - 5332D - 5333D - 5334B..... 19
 5335D - 5337D - 5343B - 5437D..... 20
 6331B - 6333B - 6334B - 6335D - 6337D..... 21
 6437D - 7501..... 22

I.S. INTERFACES

9106B - 9107B - 9113B - 9116B..... 23
 9202B - 9203B..... 24
 5104B - 5105B - 5106B - 5107B..... 25
 5114B - 5115B - 5116B - 5131B..... 26
 5202B - 5203B - 5223B - 5420B..... 27

DISPLAYS

5531A - 5531B1 - 5714 - 5715 - 5725..... 28

I.S. DISPLAYS

5531B - 5531B2..... 29

POWER SUPPLIES

3405 - 9410 - 9421..... 30

SPECIAL PRODUCTS

2224 - 2231 - 2261..... 31
 2255..... 32

BACKPLANE

..... 33

SIGNAL TYPES

..... 33

PROGRAMMING UNITS

4510 - 4511 - 4512 - 4590 - 5909..... 34

ACCESSORIES

..... 35-38

POWER RAIL

3000 power rail - 9000 power rail..... 39

ENVIRONMENTAL SPECIFICATIONS

..... 39

ENCLOSURE SPECIFICATIONS

..... 39

MULTIFUNCTIONAL TRANSMITTERS



TYPE

3114

4104

4114

4116

4131

INPUT:

RTD, TC, linear resistance, mV, mA, V, potentiometer

OUTPUT:

mA, V, relays

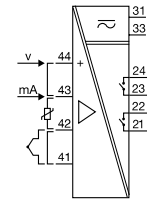
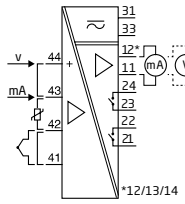
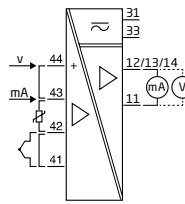
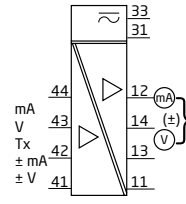
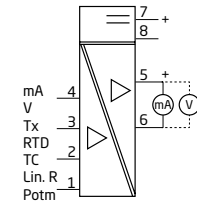

INPUT:	3114	4104	4114	4116	4131
mA, measurement range / min. span	0...23 mA / 16 mA	-23...+23 mA	0...23 mA / 16 mA	0...23 mA / 16 mA	0...23 mA / 16 mA
V, measurement range / min. span	0...12 VDC / 0.8 V	-12...+12 VDC / 0.8 V	0...12 VDC / 0.8 V	0...12 VDC / 0.8 V	0...12 VDC / 0.8 V
RTD, measurement range / min. span	-200...+850°C / 25°C		-200...+850°C / -	-200...+850°C / -	-200...+850°C / -
Lin. R, measurement range / min. span	0...10000 Ω / -		0...10000 Ω / -	0...10000 Ω / -	0...10000 Ω / -
Potentiometer	10 Ω...100 kΩ		10 Ω...100 kΩ	10 Ω...100 kΩ	10 Ω...100 kΩ
Sensor connection, wires	2 - 3 - 4		2 - 3 - 4	2 - 3 - 4	2 - 3 - 4
TC types	BEJKNRSTUW3W5Lr		BEJKNRSTUW3W5Lr	BEJKNRSTUW3W5Lr	BEJKNRSTUW3W5Lr
Cold junction compensation	Internal		Internal / external	Internal / external	Internal / external
Reference voltage / 2-wire supply	- / > 15 V	- / 16 VDC	- / 16 VDC	- / 16 VDC	- / 16 VDC
OUTPUT:					
mA, signal range / min. span	0...23 mA / 16 mA	-23...+23 mA / 16 mA	0...23 mA / 16 mA	0...23 mA / 16 mA	
Load (@ current output)	≤ 600 Ω	≤ 800 Ω	≤ 800 Ω	≤ 800 Ω	
V, signal range / min. span	0...10 VDC / 0.8 VDC	-10...+10 VDC / 0.8 VDC	0...10 VDC / 0.8 VDC	0...10 VDC / 0.8 VDC	
Load (@ voltage output)	≥ 10 kΩ	≥ 500 kΩ			
Relays				2 x SPST, AC: 500 VA	2 x SPST, AC: 500 VA
TECHNICAL SPECIFICATIONS:					
Ambient temperature	-25...+70°C	-20...+60°C	-20...+60°C	-20...+60°C	-20...+60°C
Supply voltage, universal AC / DC	- / 16.8...31.2 VDC	21.6...253V / 19.2...300V	21.6...253V / 19.2...300V	21.6...253V / 19.2...300V	21.6...253V / 19.2...300V
Max. required power	1.2 W	2.5 W	2.0 W	2.5 W	2.0 W
Isolation voltage, test / operation	2.5 kVAC / 250 VAC	2.3 kVAC / 250 VAC	2.3 kVAC / 250 VAC	2.3 kVAC / 250 VAC	2.3 kVAC / 250 VAC
Response time	0.4 / 1.0 s	< 20 ms	< 400 ms	< 400 ms	< 400 ms
Signal dynamics, input / output	24 bit / 16 bit	20 bit / 18 bit	24 bit / 16 bit	24 bit / 16 bit	24 bit / -
Accuracy	< ±0.1% of span	< ±0.05% of span	< ±0.1% of span	< ±0.1% of span	< ±0.1% of span
Temperature coefficient	< ±0.01% of span / °C	< ±0.01% of span / °C	< ±0.01% of span / °C	< ±0.01% of span / °C	< ±0.01% of span / °C
NAMUR	NE21, NE43	NE21	NE21, NE43	NE21, NE43	NE21, NE43
Channels	1	1	1	1	1
Programming	4500 series devices	4500 series devices	4500 series devices	4500 series devices	4500 series devices

APPROVALS:	3114	4104	4114	4116	4131
ATEX, Zone 2	✓				
IECEX, Zone 2	✓				
UKEX, Zone 2	✓				
FM, Zone 2 - DIV 2	✓	✓	✓	✓	✓
UL 61010 / 508	✓ / -	- / ✓	- / ✓	- / ✓	- / ✓
DNV / EU-RO marine	✓ / -	✓ / -	✓ / ✓	✓ / ✓	✓ / ✓
EAC	✓	✓	✓	✓	✓
SIL 2, Hardware Assessment			✓	✓	
CCC	✓				

APPLICATION GUIDE:	3114	4104	4114	4116	4131
mA / V / temperature input	✓ / ✓ / ✓	✓ / ✓ / -	✓ / ✓ / ✓	✓ / ✓ / ✓	✓ / ✓ / ✓
Bipolar mA / V input		✓ / ✓			
Lin. R / potentiometer input	✓ / ✓		✓ / ✓	✓ / ✓	✓ / ✓
4...20 mA Tx input	✓	✓	✓	✓	✓
V-curve function		✓			
Buffered voltage output	✓				
Active / passive current output	✓ / -	✓ / ✓	✓ / -	✓ / -	
Analog / relay output	✓ / -	✓ / -	✓ / -	✓ / ✓	- / ✓
Custom sensor linearization					
Process signal calibration	✓	✓	✓	✓	✓
Power rail option	✓				



	4179	4184	
--	------	------	--

TYPE INPUT: mV, mA, A, V, potentiometer OUTPUT: mA, V	Universal AC/DC transmitter 	Universal uni-/bipolar signal transmitter 	
--	--	--	--

INPUT:			
mA, measurement range / min. span		±100 mA / 0.5 mA	
A, measurement range / min. span	0...5 AAC / 0.5 AAC		
V, measurement range / min. span	0...300 VAC / 0.5 VAC	±300 VDC / 25 mV	
RTD, measurement range / min. span			
Lin. R, measurement range / min. span			
Potentiometer		0...100 %	
Reference voltage / 2-wire supply		2.5 V / 16 V	
3-wire supply		> 18...< 28 V	
OUTPUT:			
mA, signal range / min. span	-23...+23 mA / 16 mA	±23 mA / 4 mA	
Load (@ current output)	≤ 800 Ω	≤ 1000 Ω	
V, signal range / min. span	-10...+10 VDC / 0.8 VDC	-10...+10 VDC / 0.8 VDC	
Load (@ voltage output)	≥ 500 kΩ	≥ 500 kΩ	
Buffered voltage output		± 23 V	
Load, min. (buffered voltage output)		> 2 kΩ	
TECHNICAL SPECIFICATIONS:			
Ambient temperature	-20...+60°C	-20...+60°C	
Supply voltage, universal AC / DC	21.6...253V / 19.2...300V	21.6...253V / 19.2...300V	
Max. required power	1.8 W	2.5 W	
Isolation voltage, test / operation	2.3 kVAC / 250 VAC	2.3 kVAC / 250 VAC	
Response time	< 0.75 s	< 20 ms	
Signal dynamics, input / output	20 bit / 18 bit	24 bit / 18 bit	
Accuracy	< ±0.3% of span	< ±0.05% of span	
Temperature coefficient	< ±0.01% of span / °C	< ±0.01% of span / °C	
NAMUR	NE21, NE43	NE21, NE43	
Channels	1	1	
Programming	4500 series devices	4500 series devices	

APPROVALS:			
ATEX, Zone 2			
IECEX, Zone 2			
FM, Zone 2 - DIV 2			
UL 61010 / 508	- / ✓	- / ✓	
DNV			
EAC			
SIL 2, Hardware Assessment	✓	✓	

APPLICATION GUIDE:			
mA / V / temperature input	✓ / ✓ / -	✓ / ✓ / -	
Bipolar mA / V input		✓ / ✓	
Lin. R / potentiometer input		- / ✓	
4...20 mA Tx input		✓	
V-curve function	✓	✓	
Buffered voltage output		✓	
Active / passive current output	✓ / ✓	✓ / ✓	
Analog / relay output	✓ / -	✓ / -	
Custom sensor linearization			
Process signal calibration	✓	✓	
Power rail option			

MULTIFUNCTIONAL TRANSMITTERS

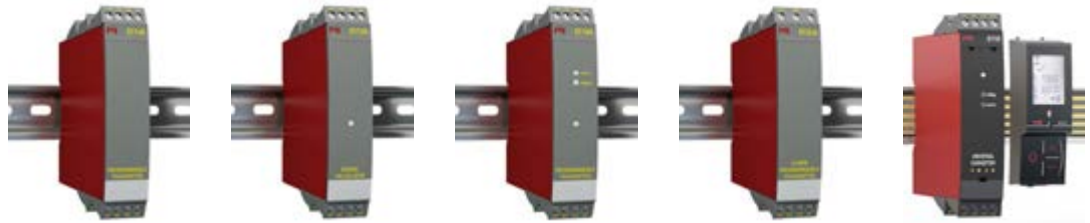

TYPE

5114A

5115A

5116A

5131A

9116A

INPUT:
RTD, TC, linear resistance, mV, mA, V, potentiometer

OUTPUT:
mA, V, relays

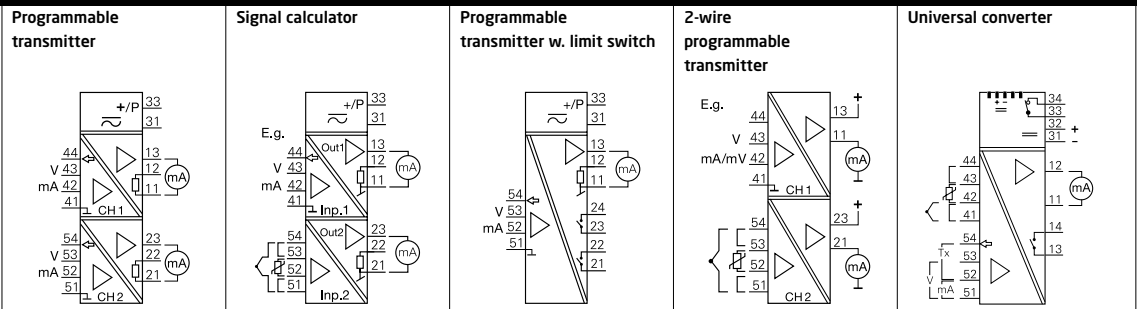

INPUT:	5114A	5115A	5116A	5131A	9116A
mA, measurement range / min. span	0...100 mA / 4 mA	0...100 mA / 4 mA	0...100 mA / 4 mA	0...100 mA / 4 mA	0...23 mA / 16 mA
V, measurement range / min. span	0...250 VDC / 5 mV	0...250 VDC / 5 mV	0...250 VDC / 5 mV	0...250 VDC / 5 mV	0...12 VDC / 0.8 V
mV, measurement range / min. span	-150...+150 mV / 5 mV	-150...+150 mV / 5 mV	-2500...+2500 mV / 5 mV	-150...+150 mV / 5 mV	
RTD, measurement range / min. span	-200...+850°C / 25°C	-200...+850°C / 25°C	-200...+850°C / 25°C	-200...+850°C / 25°C	-200...+850°C / 25°C
Lin. R, measurement range / min. span	0...5000 Ω / 30 Ω	0...5000 Ω / 30 Ω	0...5000 Ω / 30 Ω	0...5000 Ω / 30 Ω	0...10000 Ω / -
Potentiometer	200 Ω...100 kΩ	200 Ω...100 kΩ	200 Ω...100 kΩ		10 Ω...10000 Ω
Sensor connection, wires	2 - 3 - 4	2 - 3 - 4	2 - 3 - 4	2 - 3 - 4	2 - 3 - 4
TC types	BEJKLNRSTUW3W5Lr	BEJKLNRSTUW3W5Lr	BEJKLNRSTUW3W5Lr	BEJKLNRSTUW3W5Lr	BEJKLNRSTUW3W5Lr
Max. offset	50% of selec. max. value	50% of selec. max. value	50% of selec. max. value	50% of selec. max. value	
Cold junction compensation	Internal / external	Internal / external	Internal / external	Internal / external	Internal / external
Reference voltage / 2-wire supply	2.5 VDC / > 17.1 VDC	2.5 VDC / > 17.1 VDC	2.5 VDC / > 16.5 VDC		- / > 16.5 VDC
OUTPUT:					
mA, signal range / min. span	0...23 mA / 10 mA	0...23 mA / 10 mA	0...23 mA / 10 mA	3.5...23 mA / 10 mA	0...23 mA / 16 mA
Load (@ current output)	≤ 600 Ω	≤ 600 Ω	≤ 600 Ω	≤ (V _{supply} -7.5)/0.023 [Ω]	≤ 600 Ω
V, signal range / min. span	0...10 VDC / 0.5 VDC	0...10 VDC / 0.5 VDC	0...10 VDC / 0.5 VDC		
Load (@ voltage output)	≥ 500 kΩ	≥ 500 kΩ	≥ 500 kΩ		
Relays			2 x SPST, AC: 500 VA		1 x SPST, AC: 500 VA
TECHNICAL SPECIFICATIONS:					
Ambient temperature	-20...+60°C	-20...+60°C	-20...+60°C	-20...+60°C	-20...+60°C
Supply voltage, universal AC / DC	21.6...253V / 19.2...300V	21.6...253V / 19.2...300V	21.6...253 V / 19.2...300 V	- / 7.5...35 VDC	- / 19.2...31.2 VDC
Max. required power, 1 / 2 channels	2.1 W / 2.8 W	2.1 W / 2.8 W	2.4 W / -	0.8 W	≤ 2.1 W
Isolation voltage, test / operation	3.75 kVAC / 250 VAC	3.75 kVAC / 250 VAC	3.75 kVAC / 250 VAC	3.75 kVAC / 250 VAC	2.6 kVAC / 250 VAC
Response time	250 ms...60 s	250 ms...60 s	250 ms...60 s	1...60 s	0.4 / 1...60 s
Signal dynamics, input / output	22 bit / 16 bit	22 bit / 16 bit	22 bit / 16 bit	22 bit / 16 bit	24 bit / 16 bit
Accuracy	< ±0.05% of span	< ±0.05% of span	< ±0.05% of span	≤ ±0.05% of span	< ±0.1% of span
Temperature coefficient	< ±0.01% of span / °C	< ±0.01% of span / °C	< ±0.01% of span / °C	< ±0.01% of span / °C	< ±0.01% of span / °C
NAMUR	NE21, NE43	NE21, NE43	NE21, NE43	NE21, NE43	NE21, NE43
Channels	1 or 2	2	1	1 or 2	1
Programming	5909 + DIP switch	5909 + DIP switch	5909	5909 + DIP switch	4500 series devices

APPROVALS:					
ATEX, Zone 2					✓
IECEX, Zone 2					✓
FM, Zone 2					✓
UL 61010 / 508 / 913			- / ✓ / -		✓ / - / ✓
DNV	✓	✓	✓		✓
EAC	✓	✓	✓	✓	✓
SIL 2 Full Assessment IEC 61508					✓

APPLICATION GUIDE:					
mA / V / temperature input	✓ / ✓ / ✓	✓ / ✓ / ✓	✓ / ✓ / ✓	✓ / ✓ / ✓	✓ / ✓ / ✓
Bipolar mV input	✓	✓	✓	✓	✓
Lin. R / potentiometer input	✓ / ✓	✓ / ✓	✓ / ✓	✓ / -	✓ / ✓
4...20 mA Tx input	✓	✓	✓	✓	✓
Dual input - math functions		✓			
Buffered voltage output					
Active / passive current output	✓ / ✓	✓ / ✓	✓ / ✓	✓	✓ / ✓
Analog / relay output	✓ / -	✓ / -	✓ / ✓	✓ / -	✓ / ✓
Custom sensor linearization	✓	✓	✓		
Process signal calibration	✓	✓	✓	✓	✓
Power rail option					✓



TYPE	3225	4222	4225		
INPUT: Frequency, pulse, V, mA, Pt100, TC, mV	Universal frequency converter	Universal I/f converter	Universal f/I-f/f converter		
OUTPUT: mA, V, pulse, relays					

INPUT:					
Sensor type	All standard sensors \square		All standard sensors \square		
Hz, measurement range / min. span	0...100 kHz / 0.001 Hz		0...100 kHz / 0.001 Hz		
Min. pulse width	4 μ s		4 μ s		
mA, measurement range / min. span		0...23 mA / 16 mA			
V, measurement range / min. span		0...12 VDC			
RTD, measurement range / min. span		200...+850°C / -			
Lin. R, measurement range / pot.-meter		0 Ω ...10 k Ω /10 Ω ...100 k Ω			
Sensor connection, wires		2 - 3 - 4			
TC types		BEJLKNRSTUW3W5Lr			
OUTPUT:					
mA, signal range / min. span	0...23 mA / 16 mA		0...23 mA / 16 mA		
V, signal range / min. span	0...11.5 VDC / 0.8 VDC		0...11.5 VDC / 4 VDC		
Hz, signal range / min. span		0...25000 Hz / 0.001 Hz	0.001 Hz...100 kHz/0.001 Hz		
Pulse output		NPN / PNP / TTL	NPN / PNP (4225C)		
Relays	1 (3225B)		1 (4225A) / 2 (4225B)		
Max. output frequency		25 kHz	100 kHz		
Sensor supply	5...17 VDC	> 16 VDC	5...17 VDC		
TECHNICAL SPECIFICATIONS:					
Ambient temperature	-25...+70°C	-20...+60°C	-20...+60		
Supply voltage, AC / DC	16.8...31.2 VDC	21.6...253V / 19.2...300V	21.6...253V / 19.2...300V		
Max. required power, 1 / 2 channels	1.2 W	2.5 W / -	2.6 W		
Isolation voltage, test / operation	2.5 kVAC / 250 VAC	2.3 kVAC / 250 VAC	2.3 kVAC / 250 VAC		
Response time	< 30 ms	< 1 s	< 30 ms		
Signal dynamics, input / output	- / 18 bit	24 bit / -	- / 18 bit		
Accuracy	< 0.06% of span	$\leq \pm 0.1\%$ of span	< 0.06% of span		
Temperature coefficient	0.006% / °C	< $\pm 0.01\%$ of span / °C	0.006% / °C		
NAMUR	NE21, NE43	NE21	NE21, NE43		
Channels	1	1	1		
Programming	DIP switch, PR 4590	4500 series devices	4500 series devices		

APPROVALS:					
ATEX, Zone 2	✓				
IECEX, Zone 2	✓				
UKEX, Zone 2	✓				
FM, Zone 2 - DIV 2		✓			
UL 61010 / 508 / 913	✓ / - / -	- / ✓ / -	- / ✓ / -		
DNV					
EAC		✓			
SIL 2, Hardware Assessment					
SIL 2 Full Assessment IEC 61508					

APPLICATION GUIDE:					
Frequency to analog converter	✓		✓		
Analog to frequency converter		✓			
Lin. R / potentiometer input		✓ / ✓			
Concurrent f/I and f/f					
Pulse converter / scaler					
Pulse isolator 1:1					
Dual input - math functions					
Digital output		✓	✓		
Relay output	✓		✓		
Process signal calibration	✓	✓	✓		
Power rail option	✓				

ISOLATORS



TYPE

5202A

5223A

5225A

9202A

INPUT:
Frequency, pulse

OUTPUT:
mA, V, pulse, relays

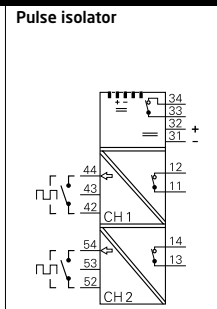
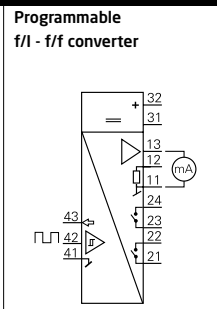
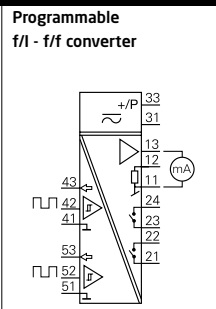
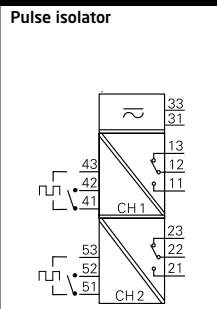

INPUT:	5202A	5223A	5225A	9202A
Sensor type	NAMUR / switch	All standard sensors \square	All standard sensors \square	NAMUR / switch
Hz, measurement range / min. span	0...5 kHz	0...20 kHz / 0.001 Hz	0...20 kHz / 0.001 Hz	0...5 kHz
Min. pulse width	> 100 μ s	25 μ s	25 μ s	> 100 μ s
OUTPUT:				
mA, signal range / min. span		0...23 mA / 5 mA	0...23 mA / 5 mA	
V, signal range / min. span		0...10 VDC / 0.25 VDC	0...10 VDC / 0.25 VDC	
Hz, signal range / min. span	0...5 kHz / -			0...5 kHz
Pulse output	NPN / relay	NPN / PNP or relays	NPN / PNP or relays	NPN / relay
Relays	2 x SPDT, AC: 100 VA	2 x SPST, AC: 500 VA	2 x SPST, AC: 500 VA	1 x SPST, AC: 500 VA
Max. output frequency		1000 Hz	1000 Hz	
Sensor supply		5...17 VDC	5...17 VDC	
TECHNICAL SPECIFICATIONS:				
Ambient temperature	-20...+60°C	-20...+60°C	-20...+60°C	-20...+60°C
Supply voltage, AC / DC	21.6...253V / 19.2...300V	21.6...253V / 19.2...300V	- / 19.2...28.8 VDC	- / 19.2...31.2 VDC
Max. required power, 1 / 2 channels	- / 1.5 W or 1.8 W*	3 W	3.5 W	\leq 1.1...1.3 W / \leq 1.5...1.9 W
Isolation voltage, test / operation	3.75 kVAC / 250 VAC	3.75 kVAC / 250 VAC	3.75 kVAC / 250 VAC	2.6 kVAC / 250 VAC
Response time		60 ms...1000 s	60 ms...1000 s	200 ms
Signal dynamics, input / output		- / 16 bit	- / 16 bit	
Accuracy		\leq \pm 0.1% of span	\leq \pm 0.1% of span	
Temperature coefficient		< \pm 0.01% of span / °C	< \pm 0.01% of span / °C	
NAMUR	NE21			NE21
Channels	2	1	1	1 or 2
Programming	DIP switch	5909 + DIP switch	5909 + DIP switch	4500 series devices

APPROVALS:	5202A	5223A	5225A	9202A
ATEX, Zone 2				✓
IECEX, Zone 2				✓
FM, Zone 2 - DIV 2				✓
UL 61010 / 508 / 913	- / ✓ / -			✓ / - / ✓
DNV				✓
EAC	✓	✓	✓	✓
SIL 2, Hardware Assessment	✓			✓
SIL 2 Full Assessment IEC 61508				✓
CCC				✓

APPLICATION GUIDE:	5202A	5223A	5225A	9202A
Frequency to analog converter		✓	✓	
Analog to frequency converter				
Lin. R / potentiometer input				
Concurrent f/I and f/f			✓	
Pulse converter / scaler		✓	✓	
Pulse isolator 1:1				✓
Dual input - math functions	✓	✓		
Digital output		✓	✓	✓
Relay output	✓	✓	✓	✓
Process signal calibration	✓	✓	✓	
Power rail option				✓

ISOLATORS

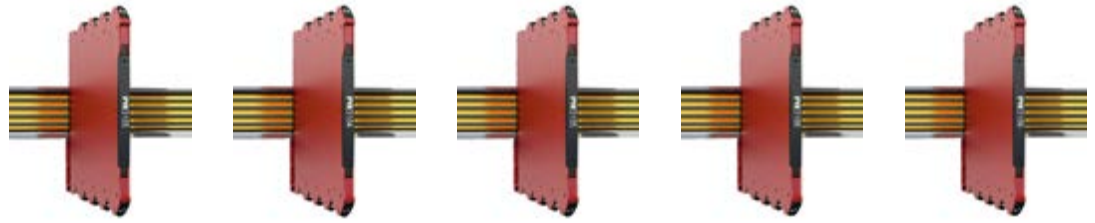

TYPE	3103	3104	3105	3108	3109
	Isolated repeater	Isolated converter	Isolated converter	Isolated repeater / splitter	Isolated converter / splitter
INPUT: mA, V, potentiometer					
OUTPUT: mA, V					
INPUT:					
mA, measurement range / min. span	0...23 mA / 1:1	0...23 mA / 16 mA	0...23 mA / 16 mA	0...23 mA / 1:1	0...23 mA / 16 mA
V, measurement range / min. span		0...10.25 VDC / 4 VDC	0...10.25 VDC / 4 VDC		0...10.25 VDC / 4 VDC
Reference voltage / 2-wire supply		- / > 17 V			- / > 17 V
OUTPUT:					
mA, signal range / min. span	0...23 mA / 1:1	0...23 mA / 16 mA	0...23 mA / 16 mA	0...23 mA / 1:1	0...23 mA / 16 mA
Load (@ current output)	≤ 600 Ω	≤ 600 Ω	≤ 600 Ω	≤ 300 Ω per channel	≤ 300 Ω per channel
V, signal range / min. span		0...10 VDC / 4 VDC	0...10 VDC / 4 VDC		0...10 VDC / 4 VDC
Load (@ voltage output)		≥ 10 kΩ	≥ 10 kΩ		≥ 10 kΩ
TECHNICAL SPECIFICATIONS:					
Ambient temperature	-25...+70°C	-25...+70°C	0...+70°C	-25...+70°C	-25...+70°C
Supply voltage, AC / DC	- / 16.8...31.2 VDC	- / 16.8...31.2 VDC	- / 16.8...31.2 VDC	- / 16.8...31.2 VDC	- / 16.8...31.2 VDC
Max. required power*	0.65 W	1.2 W	0.8 W	0.75 W	1.2 W
Isolation voltage, test / operation	2.5 kVAC / 250 VAC	2.5 kVAC / 250 VAC	2.5 kVAC / 250 VAC	2.5 kVAC / 250 VAC	2.5 kVAC / 250 VAC
Response time	< 7 ms	< 7 ms	< 7 ms	< 7 ms	< 7 ms
Signal dynamics, input / output	Analog signal chain	Analog signal chain	Analog signal chain	Analog signal chain	Analog signal chain
Accuracy	< ±0.05% of span	< ±0.05% of span	< ±0.2% of span	< ±0.05% of span	< ±0.05% of span
Temperature coefficient	< ±0.01% of span / °C	< ±0.01% of span / °C	< ±0.015% of span / °C	< ±0.01% of span / °C	< ±0.01% of span / °C
NAMUR	NE21	NE21	NE21	NE21	NE21
Channels	1	1	1	1	1
Programming	No	DIP switch	DIP switch	No	DIP switch
APPROVALS:					
ATEX, Zone 2	✓	✓		✓	✓
IECEx, Zone 2	✓	✓		✓	✓
UKEX, Zone 2	✓	✓		✓	✓
FM, Zone 2 - DIV 2	✓	✓		✓	✓
UL 61010 / 508	✓ / -	✓ / -	✓ / -	✓ / -	✓ / -
DNV	✓	✓	✓	✓	✓
EAC	✓	✓	✓	✓	✓
CCC	✓	✓		✓	✓
APPLICATION GUIDE:					
Signal repeater	✓			✓	
Signal converter		✓	✓		✓
Signal splitter				✓	✓
mA / V bipolar input					
4...20 mA Tx input		✓			✓
Buffered voltage output		✓	✓		✓
mA / V output	✓ / -	✓ / ✓	✓ / ✓	✓ / -	✓ / ✓
Active / passive mA output	✓ / -	✓ / -	✓ / -	✓ / -	✓ / -
Mounting in Zone 2 / Div 2	✓	✓	✓	✓	✓
Power rail option	✓	✓	✓	✓	✓

* = @ 24 VDC

Of span = Of the presently selected range

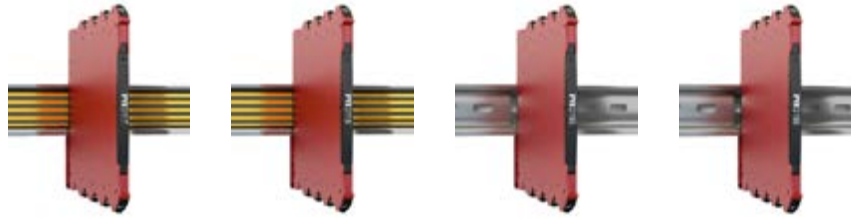

TYPE	3117	3118	3185	3186
INPUT: mA, V, potentiometer	Bipolar isolated converter	Bipolar isolated converter / splitter	Loop-powered isolator	2-wire transmitter isolator
OUTPUT: mA, V				
INPUT:				
mA, measurement range / min. span	-23...+23 mA	-23...+23 mA	0...23 mA / 1:1	3.5...23 mA / 1:1
V, measurement range / min. span	±5 and ±10 VDC	±5 and ±10 VDC		
Reference voltage / 2-wire supply				- / V _{loop} -2.5 VDC
OUTPUT:				
mA, signal range / min. span	0...23 mA / 16 mA	0...23 mA / 16 mA	0...23 mA / 1:1	3.5...23 mA / 1:1
Load (@ current output)	≤ 600 Ω	≤ 300 Ω per channel	≤ 600 Ω	
V, signal range / min. span	0...10 VDC / 4 VDC	0...10 VDC / 4 VDC		
Load (@ voltage output)	≥ 10 kΩ	≥ 10 kΩ		
TECHNICAL SPECIFICATIONS:				
Ambient temperature	-25...+70°C	-25...+70°C	-25...+70°C	-25...+70°C
Supply voltage, AC / DC	- / 16.8...31.2 VDC	- / 16.8...31.2 VDC	≤ 1.25 V + (0.015 x V _{out})	- / 6...35 VDC
Max. required power	*0.8 W	*0.8 W	30 mW per channel	50 mW per channel
Isolation voltage, test / operation	2.5 kVAC / 250 VAC	2.5 kVAC / 250 VAC	2.5 kVAC / 250 VAC	2.5 kVAC / 250 VAC
Response time	< 7 ms	< 7 ms	< 5 ms	< 5 ms
Signal dynamics, input / output	Analog signal chain	Analog signal chain	Analog signal chain	Analog signal chain
Accuracy	< ±0.05% of span	< ±0.05% of span	< ±0.1% of span	< ±0.05% of span
Temperature coefficient	< ±0.01% of span / °C	< ±0.01% of span / °C	< ±0.01% of span / °C	< ±0.01% of span / °C
NAMUR	NE21	NE21	NE21	NE21
Channels	1	1	1 or 2	1 or 2
Programming	DIP switch	DIP switch	No	No
APPROVALS:				
ATEX, Zone 2	✓	✓	✓	✓
IECEX, Zone 2	✓	✓	✓	✓
UKEX, Zone 2	✓	✓	✓	✓
FM, Zone 2 - DIV 2	✓	✓	✓	✓
UL 61010 / 508	✓ / -	✓ / -	✓ / -	✓ / -
DNV	✓	✓	✓	✓
EAC	✓	✓	✓	✓
CCC	✓	✓	✓	✓

APPLICATION GUIDE:	3117	3118	3185	3186
Signal repeater			✓	✓
Signal converter	✓	✓		
Signal splitter		✓		
mA / V bipolar input	✓	✓ / ✓		
4...20 mA Tx input				✓
Buffered voltage output	✓	✓		
Active / passive input signal			✓ / -	✓ / ✓
mA / V output	✓ / ✓	✓ / ✓	✓ / -	✓ / -
Active / passive mA output	✓ / -	✓ / -	✓ / -	- / ✓
Mounting in Zone 2 / Div 2	✓	✓	✓	✓
Power rail option	✓	✓		



TYPE	5104A	5106A	6185		
	Repeater / power supply	HART transparent repeater	Loop-powered isolator		
INPUT: mA, mV, V, HART transparent					
OUTPUT: mA, V, HART transparent					
INPUT:					
mA, measurement range / min. span	0...23 mA / 16 mA	3.5...23 mA / 1:1	0...23 mA / 1:1		
V, measurement range / min. span	0...10 VDC / 8 VDC				
Max. offset	20% of selec. max. value				
Reference voltage / 2-wire supply	- / > 17.1 VDC	- / > 17 VDC			
OUTPUT:					
mA, signal range / min. span	0...23 mA / 16 mA	3.5...23 mA / 1:1	0...23 mA / 1:1		
Load (@ current output)	≤ 600 Ω	≤ 600 Ω	≤ 600 Ω		
V, signal range / min. span	0...10 VDC / 0.8 VDC				
Load (@ voltage output)	≥ 500 kΩ				
Max. offset	20% of selec. max. value				
TECHNICAL SPECIFICATIONS:					
Ambient temperature	-20...+60°C	-20...+60°C	-20...+60°C		
Supply voltage, AC / DC	21.6...253 V / 19.2...300 V	21.6...253 V / 19.2...300 V	- / ≤ 1.8 VDC		
Max. required power, 1 / 2 channels	2.0 W / 2.8 W	2.0 W / 2.8 W	40 mW per channel		
Isolation voltage, test / operation	3.75 kVAC / 250 VAC	3.75 kVAC / 250 VAC	2 kVAC / -		
Response time	< 25 ms	< 25 ms	< 4 ms		
Signal dynamics, input / output	Analog signal chain	Analog signal chain	Analog signal chain		
Accuracy	≤ ±0.1% of span	≤ ±0.1% of span	≤ ±0.1% of span		
Temperature coefficient	< ±0.01% of span / °C	< ±0.01% of span / °C	< ±0.01% of span / °C		
NAMUR	NE21	NE21			
Channels	1 or 2	1 or 2	1, 2 or 4		
Programming	DIP switch	No	No		
APPROVALS:					
ATEX, Zone 2					
IECEX, Zone 2					
FM, Zone 2 - DIV 2					
UL 61010 / 508	- / ✓	- / ✓			
DNV	✓				
EAC	✓	✓	✓		
APPLICATION GUIDE:					
Signal repeater		✓	✓		
Signal converter	✓				
Signal splitter					
mA / V bipolar input					
4...20 mA Tx input	✓	✓			
Buffered voltage output					
Active / passive input signal				✓ / -	
mA / V output	✓ / ✓	✓ / -		✓ / -	
Active / passive mA output	✓ / ✓	✓ / ✓		✓ / -	
Mounting in Zone 2 / Div 2					
Power rail option					

ISOLATORS



TYPE	9106A	9107A	9203A		
INPUT: mA, HART communication	HART transparent repeater	HART transparent driver	Solenoid / alarm driver		
OUTPUT: mA, HART communication					
INPUT: mA, measurement range / min. span V, measurement range / min. span Max. offset Reference voltage / 2-wire supply Sensor type	3.5...23 mA / 16 mA - / > 16 VDC	3.5 ...23 mA / 16 mA	NPN / PNP / switch		
OUTPUT: mA, signal range / min. span Pulse output	3.5...23 mA / 16 mA	3.5...23 mA / 16 mA	Valves etc.		
TECHNICAL SPECIFICATIONS: Ambient temperature Supply voltage, AC / DC Max. required power, 1 / 2 channels Isolation voltage, test / operation Response time Signal dynamics, input Accuracy Temperature coefficient NAMUR Channels Programming	-20...+60°C - / 19.2...31.2 VDC ≤ 1.1 W / ≤ 1.9 W 2.6 kVAC / 250 VAC < 5 ms Analog signal chain ≤ ±16 µA ≤ ±1.6 µA / °C NE21 1 or 2 4500 series devices	-20...+60°C 19.2...31.2 VDC ≤ 1.0 W / ≤ 1.8 W 2.6 kVAC / 250 VAC < 5 ms Analog signal chain < ±16 µA < ±0.01% of span / °C NE21 1 or 2 4500 series devices	-20...+60°C 19.2...31.2 VDC ≤ 1.9...2.5 W / ≤ 3.1 W 2.6 kVAC / 250 VAC < 10 ms NE21 1 or 2 4500 series devices		
APPROVALS: ATEX, Zone 2 IECEX, Zone 2 FM, Zone 2 - DIV 2 UL 61010 / 913 DNV EAC SIL 2/3 Full Assessment IEC 61508 CCC	✓ ✓ ✓ ✓ / ✓ ✓ ✓ ✓ ✓	✓ ✓ ✓ ✓ / ✓ ✓ ✓ ✓ ✓	✓ ✓ ✓ ✓ / ✓ ✓ ✓ ✓ ✓		
APPLICATION GUIDE: Signal repeater Signal driver Signal splitter Solenoid / alarm driver mA input 4...20 mA Tx input Active / passive mA output HART signal transparent Mounting in Zone 2 / Div 2 Power rail option	✓ ✓ ✓ ✓ ✓ ✓ ✓ / ✓ ✓ ✓ ✓	✓ ✓ ✓ ✓ / - ✓ ✓ ✓ ✓	✓ ✓ ✓		

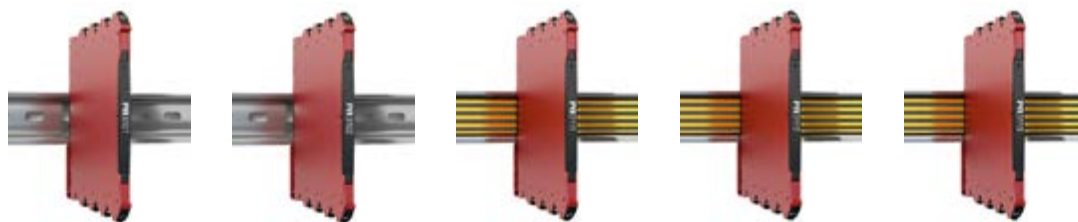

TYPE	3101	3102	3111	3112	3113
INPUT: RTD, linear resistance, TC, mV, mA, potentiometer	TC converter	Pt100 converter	TC converter - isolated	Pt100 converter - isolated	HART 7 temperature converter
OUTPUT: mA, HART communication					
INPUT:					
RTD, measurement range / min. span		-200...+850°C / 10°C		-200...+850°C / 10°C	-200...+850°C / 10°C
Lin. R, measurement range / min. span					
Sensor connection, wires		2 - 3 - 4		2 - 3 - 4	2 - 3 - 4
TC types	J & K		J & K		J & K
Max. offset					
Cold junction compensation	Internal		Internal / external		Internal / external
OUTPUT:					
mA, signal range / min. span	0...23 mA / 16 mA	0...23 mA / 16 mA	0...23 mA / 16 mA	0...23 mA / 16 mA	0...23 mA / 16 mA
Load (@ current output)	≤ 600 Ω	≤ 600 Ω	≤ 600 Ω	≤ 600 Ω	≤ 600 Ω
V, signal range / min. span	0..10 VDC / 4 VDC	0..10 VDC / 4 VDC	0..10 VDC / 4 VDC	0..10 VDC / 4 VDC	
Load (@ voltage output)	≥ 10 kΩ	≥ 10 kΩ	≥ 10 kΩ	≥ 10 kΩ	
TECHNICAL SPECIFICATIONS:					
Ambient temperature	-25...70°C	-25...70°C	-25...70°C	-25...70°C	-25...70°C
Supply voltage, DC	16.8...31.2 VDC	16.8...31.2 VDC	16.8...31.2 VDC	16.8...31.2 VDC	16.8...31.2 VDC
Max. required power*	0.52 W	0.52 W	0.7 W	0.7 W	0.7 W
Isolation voltage, test / operation			2.5 kVAC / 250 VAC	2.5 kVAC / 250 VAC	2.5 kVAC / 250 VAC
Response time	< 30 ms	< 30 ms	< 30 ms	< 30 ms	< 60 ms
Signal dynamics, input / output	23 bit / 18 bit	23 bit / 18 bit	23 bit / 18 bit	23 bit / 18 bit	23 bit / 18 bit
Accuracy	≤ ±0.1% of span	≤ ±0.1% of span	≤ ±0.05% of span	≤ ±0.05% of span	≤ ±0.05% of span
Temperature coefficient	< ±0.01% of span / °C	< ±0.01% of span / °C	< ±0.01% of span / °C	< ±0.01% of span / °C	< ±0.01% of span / °C
NAMUR	NE21, NE43	NE21, NE43	NE21, NE43	NE21, NE43	NE21, NE43
Channels	1	1	1	1	1
Programming	DIP switch	DIP switch	DIP switch	DIP switch	DIP switch / HART
APPROVALS:					
ATEX, Zone 2	✓	✓	✓	✓	✓
IECEX, Zone 2	✓	✓	✓	✓	✓
UKEX, Zone 2	✓	✓	✓	✓	✓
FM, Zone 2 - DIV 2	✓	✓	✓	✓	✓
UL 61010 / 508	✓ / -	✓ / -	✓ / -	✓ / -	✓ / -
DNV	✓	✓	✓	✓	✓
EAC	✓	✓	✓	✓	✓
APPLICATION GUIDE:					
RTD / TC / mV input	- / ✓ / -	✓ / - / -	- / ✓ / -	✓ / - / -	✓ / ✓ / -
mA / V output	✓ / ✓	✓ / ✓	✓ / ✓	✓ / ✓	✓ / -
Loop-powered					
Galvanically isolated			✓	✓	✓
HART protocol					✓
Mounting in Zone 2 / DIV 2	✓ / ✓	✓ / ✓	✓ / ✓	✓ / ✓	✓ / ✓
Process signal calibration					✓
Power rail option			✓	✓	✓

* = @ 24 VDC

Of span = Of the presently selected range

TEMPERATURE TRANSMITTERS



TYPE	3331	3333	3337		
INPUT: RTD, linear resistance, TC, mV	Temperature converter, loop-powered - isolated	Pt100 converter, loop- powered	HART 7 temperature converter, loop-powered		
OUTPUT: mA, V, HART communication					
INPUT:					
RTD, measurement range / min. span	-200...+850°C / 10°C	-200...+850°C / 10°C	-200...+850°C / 10°C		
Lin. R, measurement range / min. span					
Sensor connection, wires	2 - 3 - 4	2 - 3 - 4	2 - 3 - 4		
TC types	J & K		J & K		
Max. offset					
Cold junction compensation	Internal / external		Internal / external		
OUTPUT:					
mA, signal range / min. span	3.5...23 mA / 16 mA	3.5...23 mA / 16 mA	3.5...23 mA / 16 mA		
Load (@ current output)	$\leq (V_{\text{supply}} - 5.5) / 0.023 [\Omega]$	$\leq (V_{\text{supply}} - 3.3) / 0.023 [\Omega]$	$\leq (V_{\text{supply}} - 6.2) / 0.023 [\Omega]$		
TECHNICAL SPECIFICATIONS:					
Ambient temperature	-25...70°C	-25...70°C	-25...70°C		
Supply voltage, DC	5.5...35 VDC	3.3...35 VDC	6.2...35 VDC		
Max. required power	0.8 W	0.8 W	0.8 W		
Isolation voltage, test / operation	2.5 kVAC / 250 VAC		2.5 kVAC / 250 VAC		
Response time	< 30 ms	< 30 ms	< 60 ms		
Signal dynamics, input / output	23 bit / 18 bit	23 bit / 18 bit	23 bit / 18 bit		
Accuracy	$\leq \pm 0.05\%$ of span	$\leq \pm 0.1\%$ of span	$\leq \pm 0.05\%$ of span		
Temperature coefficient	$< \pm 0.01\%$ of span / °C	$< \pm 0.01\%$ of span / °C	$< \pm 0.01\%$ of span / °C		
NAMUR	NE21, NE43	NE21, NE43	NE21, NE43		
Channels	1	1	1		
Programming	DIP switch	DIP switch	DIP switch / HART		
APPROVALS:					
ATEX, Zone 2	✓	✓	✓		
IECEX, Zone 2	✓	✓	✓		
UKEX, Zone 2	✓	✓	✓		
FM, Zone 2 - DIV 2	✓	✓	✓		
UL 61010 / 508	✓ / -	✓ / -	✓ / -		
DNV	✓	✓	✓		
EAC	✓	✓	✓		
APPLICATION GUIDE:					
RTD / TC / mV input	✓ / ✓ / -	✓ / - / -	✓ / ✓ / -		
mA / V output	✓ / -	✓ / -	✓ / -		
Loop-powered	✓	✓	✓		
Galvanically isolated	✓		✓		
HART protocol			✓		
Mounting in Zone 2 / DIV 2	✓ / ✓	✓ / ✓	✓ / ✓		
Process signal calibration			✓		

TEMPERATURE TRANSMITTERS



TYPE	5331A	5332A	5333A	5334A
INPUT: RTD, linear resistance, TC, mV, potentiometer	2-wire programmable transmitter	2-wire programmable RTD transmitter	2-wire programmable transmitter	2-wire programmable transmitter
OUTPUT: mA				

INPUT:				
mV, measurement range / min. span	-12...800 mV / 5 mV			-12...150 mV / 5 mV
RTD, measurement range / min. span	-200...+850°C / 25°C	-200...+850°C / 25°C	-200...+850°C / 25°C	
Lin. R, measurement range / min. span	0...5000 Ω / 30 Ω	0...5000 Ω / 30 Ω	0...10 kΩ / 30 Ω	
Potentiometer				
Sensor connection, wires	2 - 3 - 4	2 - 3 - 4	2 - 3	
TC types	BEJKLNRSTUW3W5Lr			BEJKLNRSTUW3W5Lr
Max. offset	50% of selec. max. value	50% of selec. max. value	50% of selec. max. value	50% of selec. max. value
Cold junction compensation	Internal / external			Internal
OUTPUT:				
mA, signal range / min. span	3.5...23 mA / 16 mA	3.5...23 mA / 16 mA	3.5...23 mA / 16 mA	3.5...23 mA / 16 mA
TECHNICAL SPECIFICATIONS:				
Ambient temperature	-40...+85°C	-40...+85°C	-40...+85°C	-40...+85°C
Supply voltage, DC	7.2...35 VDC	7.2...35 VDC	8...35 VDC	7.2...35 VDC
Max. required power	0.8 W	0.8 W	0.8 W	0.8 W
Isolation voltage, test / operation	1500 VAC / 50 V			1500 VAC / 50 V
Response time	1...60 s	1...60 s	0.33...60 s	1...60 s
Signal dynamics, input / output	20 bit / 16 bit	20 bit / 16 bit	19 bit / 16 bit	18 bit / 16 bit
Accuracy	≤ ±0.05% of span	≤ ±0.05% of span	≤ ±0.1% of span	≤ ±0.05% of span
Temperature coefficient	< ±0.01% of span / °C	< ±0.01% of span / °C	< ±0.01% of span / °C	< ±0.01% of span / °C
NAMUR	NE21, NE43	NE43	NE43	NE21, NE43
Channels	1	1	1	1
Programming	5909	5909	5909	5909

APPROVALS:				
ATEX, Zone 2	✓	✓	✓	✓
IECEX, Zone 2	✓	✓	✓	✓
CSA, Zone 2 - DIV 2	✓	✓	✓	
FM, Zone 2 - DIV 2				
INMETRO	✓		✓	✓
NEPSI				
DNV	✓		✓	✓
EAC	✓		✓	✓
SIL Hardware Assessment				

APPLICATION GUIDE:				
RTD / TC / mV input	✓ / ✓ / ✓	✓ / - / -	✓ / - / -	- / ✓ / ✓
Lin. R / potentiometer input	✓ / -	✓ / -	✓ / -	
Dual input (4 terminals)				
Custom sensor linearization	✓	✓	✓	✓
mA output	✓	✓	✓	✓
Loop-powered	✓	✓	✓	✓
Galvanically isolated	✓			✓
HART protocol				
Mounting in Zone 2 / DIV 2	✓ / -	✓ / -	✓ / -	✓ / -
Process signal calibration	✓	✓	✓	✓

TEMPERATURE TRANSMITTERS



TYPE	5335A	5337A	5343A	5437A
INPUT: RTD, linear resistance, TC, mV, potentiometer	2-wire transmitter with HART 5 protocol	2-wire transmitter with HART 7 protocol	2-wire level transmitter	2-wire HART 7 temperature transmitter
OUTPUT: mA, HART communication				
INPUT:				
mV, measurement range	-800...+800 mV	-800...+800 mV		± 800 mV, -0.1...+1.7 V
mV, min. span	2.5 mV	2.5 mV		2.5 mV
RTD, measurement range / min. span	-200...+850°C / 10°C	-200...+850°C / 10°C		-200...+850°C / 10°C
Lin. R, measurement range / min. span	0...7000 Ω / 25 Ω	0...7000 Ω / 25 Ω		0...100 kΩ / 25 Ω
Potentiometer			0...100 kΩ / 1 kΩ	10 Ω...100 kΩ / 10%
Sensor connection, wires	2 - 3 - 4	2 - 3 - 4		2 - 3 - 4
TC types	BEJKNRSTUW3W5	BEJKNRSTUW3W5		BEJKNRSTUW3W5Lr
Max. offset	50% of selec. max. value	50% of selec. max. value	50% of selec. max. value	
Cold junction compensation	Internal / external	Internal / external	Internal / external	Internal / external
OUTPUT:				
mA, signal range / min. span	3.5...23 mA / 16 mA	3.5...23 mA / 16 mA	3.5...23 mA / 16 mA	3.5...23 mA / 16 mA
TECHNICAL SPECIFICATIONS:				
Ambient temperature	-40...+85°C	-40...+85°C	-40...+85°C	-50...+85°C
Supply voltage, DC	8...35 VDC	8...35 VDC	8...35 VDC	7.5...48 VDC
Max. required power	0.8 W	0.8 W	0.8 W	< 850 mW
Isolation voltage, test / operation	1500 VAC / 50 V	1500 VAC / 50 V		2.5 kVAC / 55 VAC
Response time	1...60 s	1...60 s	0.33...60 s	70 ms
Signal dynamics, input / output	22 bit / 16 bit	22 bit / 16 bit	19 bit / 16 bit	24 bit / 18 bit
Accuracy	≤ ±0.05% of span	≤ ±0.05% of span	≤ ±0.1% of span	≤ ±0.05% of span
Temperature coefficient	< ±0.005% of span / °C	< ±0.005% of span / °C	≤ ±0.01% of span / °C	< ±0.005% of span / °C
NAMUR	NE21, NE43, NE89	NE21, NE43, NE89	NE43	NE 21/43/44/89/95/107/130
Channels	1	1	1	1 or 2*
Programming	5909/HART 5	5909/HART 7/HART 5	5909	5909 / HART 7 / HART 5
APPROVALS:				
ATEX, Zone 2	✓	✓	✓	✓
IECEX, Zone 2	✓	✓	✓	✓
CSA, Zone 2 - DIV 2	✓	✓		✓
FM, Zone 2 - DIV 2				✓
INMETRO	✓	✓	✓	✓
NEPSI				✓
DNV / EU-RO marine	✓ / -	✓ / -	✓ / -	- / ✓
EAC	✓	✓	✓	✓
SIL Hardware Assessment	✓	✓		
SIL 2/3 Full Assessment IEC 61508				✓ / ✓
APPLICATION GUIDE:				
RTD / TC / mV input	✓ / ✓ / ✓	✓ / ✓ / ✓		✓ / ✓ / ✓
Lin. R / potentiometer input	✓ / -	✓ / -	✓ / ✓	✓ / ✓
Dual input (4 terminals)	✓	✓		
True dual input (7 terminals)				✓
Custom sensor linearization	✓	✓	✓	✓
mA output	✓	✓	✓	✓
Loop-powered	✓	✓	✓	✓
Galvanically isolated	✓	✓		✓
HART protocol	✓	✓		✓
Mounting in Zone 2 / DIV 2	✓ / -	✓ / -	✓ / -	✓ / ✓
Process signal calibration	✓	✓	✓	✓



TEMPERATURE TRANSMITTERS

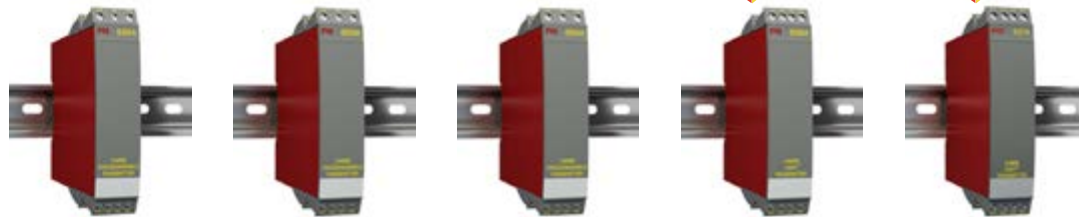

TYPE	6331A	6333A	6334A	6335A	6337A
INPUT: RTD, linear resistance, TC, mV, potentiometer	2-wire programmable transmitter	2-wire programmable transmitter	2-wire programmable transmitter	2-wire HART 5 transmitter	2-wire HART 7 transmitter
OUTPUT: mA, HART communication					
INPUT:					
mV, measurement range / min. span	-12...800 mV / 5 mV		-12...+150 mV / 5 mV	-800...+800 mV / 2.5 mV	-800...+800 mV / 2.5 mV
RTD, measurement range / min. span	-200...+850°C / 25°C	-200...+850°C / 25°C		-200...+850°C / 10°C	-200...+850°C / 10°C
Lin. R, measurement range / min. span	0...5000 Ω / 30 Ω	0...10 kΩ / 30 Ω		0...7000 Ω / 25 Ω	0...7000 Ω / 25 Ω
Potentiometer					
Sensor connection, wires	2 - 3 - 4	2 - 3		2 - 3 - 4	2 - 3 - 4
TC types	BEJKNRSTUW3W5Lr		BEJKNRSTUW3W5Lr	BEJKNRSTUW3W5	BEJKNRSTUW3W5
Max. offset	50% of selec. max. value	50% of selec. max. value	50% of selec. max. value	50% of selec. max. value	50% of selec. max. value
Cold junction compensation	Internal / external		Internal	Internal / external	Internal / external
OUTPUT:					
mA, signal range / min. span	3.5...23 mA / 16 mA	3.5...23 mA / 16 mA	3.5...23 mA / 16 mA	3.5...23 mA / 16 mA	3.5...23 mA / 16 mA
TECHNICAL SPECIFICATIONS:					
Ambient temperature	-40...+85°C	-40...+85°C	-40...+85°C	-40...+85°C	-40...+85°C
Supply voltage, DC	7.2...35 VDC	8...35 VDC	7.2...35 VDC	8...35 VDC	8...35 VDC
Max. required power, 1 / 2 channels	0.8 W / 1.6 W	0.8 W / 1.6 W	0.8 W / 1.6 W	0.8 W / 1.6 W	0.8 W / 1.6 W
Isolation voltage, test / operation	1500 VAC / 50 V		1500 VAC / 50 V	1500 VAC / 50 V	1500 VAC / 50 V
Response time	1...60 s	0.33...60 s	1...60 s	1...60 s	1...60 s
Signal dynamics, input / output	20 bit / 16 bit	19 bit / 16 bit	18 bit / 16 bit	22 bit / 16 bit	22 bit / 16 bit
Accuracy	≤ ±0.05% of span	≤ ±0.1% of span	≤ ±0.05% of span	≤ ±0.05% of span	≤ ±0.05% of span
Temperature coefficient	< ±0.01% of span / °C	< ±0.01% of span / °C	< ±0.01% of span / °C	< ±0.005% of span / °C	< ±0.005% of span / °C
NAMUR	NE21, NE43	NE43	NE21, NE43	NE21, NE43, NE89	NE21, NE43, NE89
Channels	1 or 2	1 or 2	1 or 2	1 or 2	1 or 2
Programming	5909	5909	5909	5909/HART 5	5909/HART 7/HART 5
APPROVALS:					
ATEX, Zone 2	✓	✓	✓	✓	✓
IECEX, Zone 2	✓	✓	✓	✓	✓
CSA, Zone 2 - DIV 2	✓	✓		✓	✓
FM, Zone 2 - DIV 2					
UL 61010 / 508					
DNV					
EAC	✓	✓	✓	✓	✓
SIL Hardware Assessment				✓	✓
SIL 2 Full Assessment IEC 61508					
APPLICATION GUIDE:					
RTD / TC / mV input	✓ / ✓ / ✓	✓ / - / -	- / ✓ / ✓	✓ / ✓ / ✓	✓ / ✓ / ✓
Lin. R / potentiometer input	✓ / -	✓ / -		✓ / -	✓ / -
Dual input (4 terminals)				✓	✓
Custom sensor linearization	✓	✓	✓	✓	✓
mA output	✓	✓	✓	✓	✓
Loop-powered	✓	✓	✓	✓	✓
Galvanically isolated	✓		✓	✓	✓
HART protocol				✓	✓
Mounting in Zone 2 / DIV 2	✓ / -	✓ / -	✓ / -	✓ / -	✓ / -
Process signal calibration	✓	✓	✓	✓	✓

TEMPERATURE TRANSMITTERS



TYPE	6437A	7501	9113A		
INPUT: RTD, linear resistance, TC, mV, mA, potentiometer	2-wire HART 7 temperature transmitter	Field mounted HART temperature transmitter	Temperature / mA converter		
OUTPUT: mA, HART communication					
INPUT:					
mA, measurement range / min. span			0...23 mA / 16 mA		
mV, measurement range	± 800 mV, -0.1...+1.7 V	-800...+800 mV			
mV, min. span	2.5 mV	2.5 mV			
RTD, measurement range / min. span	-200...+850°C / 10°C	-200...+850°C / 10°C	-200...+850°C / 25°C		
Lin. R, measurement range / min. span	0...100 kΩ / 25 Ω	0...7000 Ω / 25 Ω			
Potentiometer	10 Ω...100 kΩ / 10%				
Sensor connection, wires	2 - 3 - 4	2 - 3 - 4	2 - 3 - 4		
TC types	BEJLNRSTUW3W5Lr	BEJLNRSTUW3W5	BEJLNRSTUW3W5Lr		
Cold junction compensation	Internal / external	Internal / external	Internal / external		
OUTPUT:					
mA, signal range / min. span	3.5...23 mA / 16 mA	3.5...23 mA / 16 mA	0...23 mA / 16 mA		
TECHNICAL SPECIFICATIONS:					
Ambient temperature	-50...+85°C	-40...+85°C	-20...+60°C		
Supply voltage, DC	7.5...48 VDC	10 / 12...35 VDC	19.2...31.2 VDC		
Max. required power, 1 / 2 channels	< 850 mW / -		≤ 0.8 W / ≤ 1.4 W		
Isolation voltage, test / operation	2.5 kVAC / 55 VAC	1500 VAC / 50 VAC	2.6 kVAC / 250 VAC		
Response time	70 ms	22 bit / 16 bit	0.4 / 1...60 s		
Signal dynamics, input / output	24 bit / 18 bit	1...60 s	24 bit / 16 bit		
Accuracy	± ±0.05% of span	± ±0.05% of span	± ±0.1% of span		
Temperature coefficient	< ±0.005% of span / °C	< ±0.005% of span / °C	< ±0.01% of span / °C		
NAMUR	NE21 / 43 / 44 / 89 / 107	NE21, NE43	NE21, NE43		
Channels	1 or 2*	1	1 or 2		
Programming	5909 / HART 7 / HART 5	LOI / HART	4500 series devices		
APPROVALS:					
ATEX, Zone 2	✓	✓	✓		
IECEX, Zone 2	✓	✓			
CSA, Zone 2 - DIV 2	✓				
FM, Zone 2 - DIV 2	✓				
INMETRO / NEPSI	✓ / ✓				
UL 61010 / 913			✓ / ✓		
DNV / EU-RO marine	- / ✓	- / ✓	✓ / -		
EAC	✓	✓	✓		
SIL Hardware Assessment		✓			
SIL 2/3 Full Assessment IEC 61508	✓ / ✓		✓ / -		
APPLICATION GUIDE:					
RTD / TC / mV input	✓ / ✓ / ✓	✓ / ✓ / ✓	✓ / ✓ / -		
Lin. R / potentiometer input	✓ / ✓	✓ / -			
Dual input (4 terminals)		✓			
True dual input (8 terminals)	✓				
Custom sensor linearization	✓	✓			
mA output	✓	✓	✓		
Loop-powered	✓	✓			
Galvanically isolated	✓	✓	✓		
HART protocol	✓	✓			
Process signal calibration	✓	✓	✓		
Power rail option			✓		



TYPE	5331D	5332D	5333D	5334B
INPUT: RTD, linear resistance, TC, mV, potentiometer	2-wire programmable transmitter	2-wire programmable RTD transmitter	2-wire programmable transmitter	2-wire programmable transmitter
OUTPUT: mA				

INPUT:				
mV, measurement range / min. span	-12...800 mV / 5 mV	-200...+850°C / 25°C	-200...+850°C / 25°C	-12...150 mV / 5 mV
RTD, measurement range / min. span	-200...+850°C / 25°C	-200...+850°C / 25°C	-200...+850°C / 25°C	
Lin. R, measurement range / min. span	0...5000 Ω / 30 Ω	0...5000 Ω / 30 Ω	0...10 kΩ / 30 Ω	
Potentiometer				
Sensor connection, wires	2 - 3 - 4	2 - 3 - 4	2 - 3	
TC types	BEJKNRSTUW3W5Lr			BEJKNRSTUW3W5Lr
Max. offset				
Cold junction compensation	Internal / external	Internal / external		Internal
OUTPUT:				
mA, signal range / min. span	3.5...23 mA / 16 mA	3.5...23 mA / 16 mA	3.5...23 mA / 16 mA	3.5...23 mA / 16 mA
TECHNICAL SPECIFICATIONS:				
Ambient temperature	-40...+85°C	-40...+85°C	-40...+85°C	-40...+85°C
Supply voltage, DC	7.2...30 VDC	7.2...30 VDC	8...30 VDC	7.2...30 VDC
Max. required power	0.7 W	0.7 W	0.7 W	0.7 W
Isolation voltage, test / operation	1500 VAC / 50 V			1500 VAC / 50 V
Response time	1...60 s	1...60 s	0.33...60 s	1...60 s
Signal dynamics, input / output	20 bit / 16 bit	20 bit / 16 bit	19 bit / 16 bit	18 bit / 16 bit
Accuracy	≤ ±0.05% of span	≤ ±0.05% of span	≤ ±0.1% of span	≤ ±0.05% of span
Temperature coefficient	< ±0.01% of span / °C	< ±0.01% of span / °C	< ±0.01% of span / °C	< ±0.01% of span / °C
NAMUR	NE21, NE43	NE21, NE43	NE43	NE21, NE43
Channels	1	1	1	1
Programming	5909	5909	5909	5909

APPROVALS:				
ATEX	✓	✓	✓	✓
IECEx	✓	✓	✓	✓
FM	✓	✓	✓	✓
CSA	✓	✓	✓	✓
INMETRO	✓	✓	✓	✓
DNV	✓	✓	✓	✓
EAC Ex	✓	✓	✓	✓
NEPSI				
SIL Hardware Assessment				

APPLICATION GUIDE:				
RTD / TC / mV input	✓/✓/✓	✓/-/-	✓/-/-	-/✓/✓
Lin. R / potentiometer input	✓/-	✓/-	✓/-	
Dual input (4 terminals)				
Custom sensor linearization	✓	✓	✓	✓
mA output	✓	✓	✓	✓
Loop-powered	✓	✓	✓	✓
Galvanically isolated	✓	✓	✓	✓
HART protocol				
Process signal calibration	✓	✓	✓	✓

I.S. TEMPERATURE TRANSMITTERS



TYPE

5335D

5337D

5343B

5437D

INPUT:

RTD, linear resistance,
TC, mV, potentiometer

OUTPUT:

mA,
HART communication

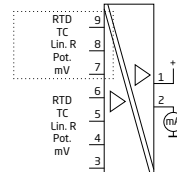
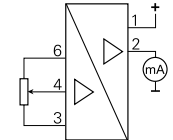
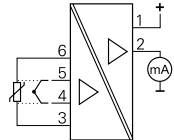
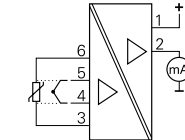

INPUT:

mV, measurement range	-800...+800 mV	-800...+800 mV		± 800 mV, -0.1...+1.7 V
mV, min. span	2.5 mV	2.5 mV		2.5 mV
RTD, measurement range / min. span	-200...+850°C / 10°C	-200...+850°C / 10°C		-200...+850°C / 10°C
Lin. R, measurement range / min. span	0...7000 Ω / 25 Ω	0...7000 Ω / 25 Ω	0...100 kΩ / 1 kΩ	0...100 kΩ / 25 Ω
Potentiometer			1 kΩ...100 kΩ	10 Ω...100 kΩ / 10%
Sensor connection, wires	2 - 3 - 4	2 - 3 - 4		2 - 3 - 4
TC types	BEJKNRSTUW3W5	BEJKNRSTUW3W5		BEJKNRSTUW3W5Lr
Max. offset			50% of selec. max. value	
Cold junction compensation	Internal / external	Internal / external		Internal / external

OUTPUT:

mA, signal range / min. span	3.5...23 mA / 16 mA	3.5...23 mA / 16 mA	3.5...23 mA / 16 mA	3.5...23 mA / 16 mA
------------------------------	---------------------	---------------------	---------------------	---------------------

TECHNICAL SPECIFICATIONS:

Ambient temperature	-40...+85°C	-40...+85°C	-40...+85°C	-50...+85°C
Supply voltage, DC	8...30 VDC	8...30 VDC	8...30 VDC	7.5...30 VDC
Max. required power	0.7 W	0.7 W	0.7 W	< 850 mW
Isolation voltage, test / operation	1500 VAC / 50 V	1500 VAC / 50 V		2.5 kVAC / 42 VAC
Response time	1...60 s	1...60 s	0.33...60 s	70 ms
Signal dynamics, input / output	22 bit / 16 bit	22 bit / 16 bit	19 bit / 16 bit	24 bit / 18 bit
Accuracy	≤ ±0.05% of span	≤ ±0.05% of span	≤ ±0.1% of span	≤ ±0.05% of span
Temperature coefficient	< ±0.005% of span / °C	< ±0.005% of span / °C	≤ ±0.01% of span / °C	< ±0.005% of span / °C
NAMUR	NE21, NE43, NE89	NE21, NE43, NE89	NE43	NE21/43/44/89/95/107/130
Channels	1	1	1	1 or 2*
Programming	5909/HART 5	5909/HART 7/HART 5	5909	5909 / HART 7 / HART 5

APPROVALS:

ATEX	✓	✓	✓	✓
IECEX	✓	✓	✓	✓
FM	✓	✓	✓	✓
CSA	✓	✓	✓	✓
INMETRO	✓	✓	✓	✓
DNV / EU-RO marine	✓ / -	✓ / -	✓ / -	- / ✓
EAC Ex			✓	✓
NEPSI				✓
SIL Hardware Assessment	✓	✓		
SIL 2/3 Full Assessment IEC 61508				✓ / ✓

APPLICATION GUIDE:

RTD / TC / mV input	✓ / ✓ / ✓	✓ / ✓ / ✓		✓ / ✓ / ✓
Lin. R / potentiometer input	✓ / -	✓ / -	✓ / ✓	✓ / ✓
Dual input (4 terminals)	✓	✓		
True dual input (7 terminals)			✓	✓
Custom sensor linearization	✓	✓	✓	✓
mA output	✓	✓	✓	✓
Loop-powered	✓	✓		✓
Galvanically isolated	✓	✓		✓
HART protocol	✓	✓	✓	✓
Process signal calibration	✓	✓		✓



I.S. TEMPERATURE TRANSMITTERS

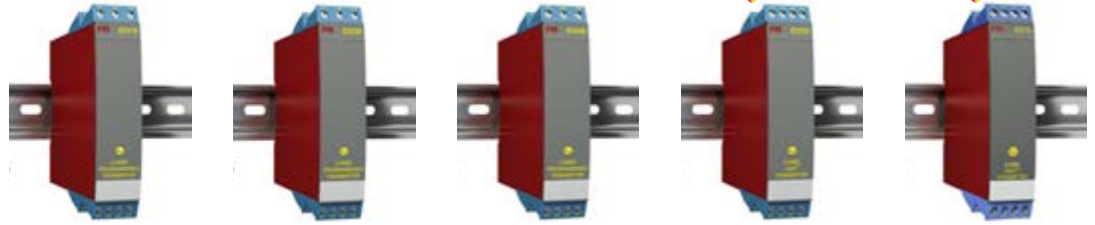

TYPE	6331B	6333B	6334B	6335D	6337D
INPUT: RTD, linear resistance, TC, mV, potentiometer	2-wire programmable transmitter	2-wire programmable transmitter	2-wire programmable transmitter	2-wire HART 5 transmitter	2-wire HART 7 transmitter
OUTPUT: mA, HART communication					
INPUT:					
mV, measurement range / min. span	-12...800 mV / 5 mV	-12...800 mV / 5 mV	-12...+150 mV / 5 mV	-800...+800 mV / 2.5 mV	-800...+800 mV / 2.5 mV
RTD, measurement range / min. span	-200...+850°C / 25°C	-200...+850°C / 25°C	-200...+850°C / 25°C	-200...+850°C / 10°C	-200...+850°C / 10°C
Lin. R, measurement range / min. span	0...5000 Ω / 30 Ω	0...10 kΩ / 30 Ω	0...10 kΩ / 30 Ω	0...7000 Ω / 25 Ω	0...7000 Ω / 25 Ω
Potentiometer					
Sensor connection, wires	2 - 3 - 4	2 - 3	2 - 3 - 4	2 - 3 - 4	2 - 3 - 4
TC types	BEJKNRSTUW3W5Lr	BEJKNRSTUW3W5Lr	BEJKNRSTUW3W5Lr	BEJKNRSTUW3W5	BEJKNRSTUW3W5
Max. offset	50% of selec. max. value	50% of selec. max. value	50% of selec. max. value	50% of selec. max. value	50% of selec. max. value
Cold junction compensation	Internal / external	Internal / external	Internal / external	Internal / external	Internal / external
OUTPUT:					
mA, signal range / min. span	3.5...23 mA / 16 mA	3.5...23 mA / 16 mA	3.5...23 mA / 16 mA	3.5...23 mA / 16 mA	3.5...23 mA / 16 mA
TECHNICAL SPECIFICATIONS:					
Ambient temperature	-40...+85°C	-40...+85°C	-40...+85°C	-40...+85°C	-40...+85°C
Supply voltage, DC	7.2...30 VDC	8...30 VDC	7.2...30 VDC	8...30 VDC	8...30 VDC
Max. required power, 1 / 2 channels	0.7 W / 1.4 W	0.7 W / 1.4 W	0.7 W / 1.4 W	0.7 W / 1.4 W	0.7 W / 1.4 W
Isolation voltage, test / operation	1500 VAC / 50 V	1500 VAC / 50 V	1500 VAC / 50 V	1500 VAC / 50 V	1500 VAC / 50 V
Response time	1...60 s	0.33...60 s	1...60 s	1...60 s	1...60 s
Signal dynamics, input / output	20 bit / 16 bit	19 bit / 16 bit	18 bit / 16 bit	22 bit / 16 bit	22 bit / 16 bit
Accuracy	≤ ±0.05% of span	≤ ±0.1% of span	≤ ±0.05% of span	≤ ±0.05% of span	≤ ±0.05% of span
Temperature coefficient	< ±0.01% of span / °C	< ±0.01% of span / °C	< ±0.01% of span / °C	< ±0.005% of span / °C	< ±0.005% of span / °C
NAMUR	NE21, NE43	NE43	NE21, NE43	NE21, NE43, NE89	NE21, NE43, NE89
Channels	1 or 2	1 or 2	1 or 2	1 or 2	1 or 2
Programming	5909	5909	5909	5909/HART 5	5909/HART 7/HART 5
APPROVALS:					
ATEX	✓	✓	✓	✓	✓
IECEX	✓	✓	✓	✓	✓
FM	✓	✓	✓	✓	✓
CSA	✓	✓	✓	✓	✓
UL					
DNV					
EAC Ex	✓	✓	✓	✓	✓
SIL Hardware Assessment				✓	✓
APPLICATION GUIDE:					
RTD / TC / mV input	✓/✓/✓	✓/✓/✓	✓/✓/✓	✓/✓/✓	✓/✓/✓
Lin. R / potentiometer input	✓/✓	✓/✓	✓/✓	✓/✓	✓/✓
Dual input (4 terminals)	✓	✓	✓	✓	✓
Custom sensor linearization	✓	✓	✓	✓	✓
mA output	✓	✓	✓	✓	✓
Loop-powered	✓	✓	✓	✓	✓
Galvanically isolated	✓	✓	✓	✓	✓
HART protocol	✓	✓	✓	✓	✓
Process signal calibration	✓	✓	✓	✓	✓

I.S. TEMPERATURE TRANSMITTERS



TYPE

6437D

7501

INPUT:

RTD, linear resistance,
TC, mV, potentiometer

OUTPUT:

mA,
HART communication

2-wire HART 7
temperature transmitter

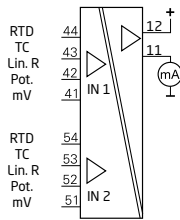

Field mounted HART
temperature transmitter

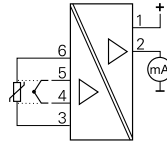

INPUT:

mV, measurement range	± 800 mV, -0.1...+1.7 V	-800...+800 mV
mV, min. span	2.5 mV	2.5 mV
RTD, measurement range / min. span	-200...+850°C / 10°C	-200...+850°C / 10°C
Lin. R, measurement range / min. span	0...100 kΩ / 25 Ω	0...7000 Ω / 25 Ω
Potentiometer	10 Ω...100 kΩ / 10%	
Sensor connection, wires	2 - 3 - 4	2 - 3 - 4
TC types	BEJLNRSTUW3W5Lr	BEJLNRSTUW3W5
Cold junction compensation	Internal / external	Internal / external

OUTPUT:

mA, signal range / min. span	3.5...23 mA / 16 mA	3.5...23 mA / 16 mA
------------------------------	---------------------	---------------------

TECHNICAL SPECIFICATIONS:

Ambient temperature	-50...+85°C	-40...+85°C
Supply voltage, DC	7.5...30 VDC	10 / 12...30 VDC
Max. required power, 1 / 2 channels	< 850 mW / -	
Isolation voltage, test / operation	2.5 kVAC / 42 VAC	1500 VAC / 50 V
Signal dynamics, input / output	70 ms	22 bit / 16 bit
Response time	24 bit / 18 bit	1...60 s
Accuracy	≤ ±0.05% of span	≤ ±0.05% of span
Temperature coefficient	< ±0.005% of span / °C	< ±0.005% of span / °C
NAMUR	NE21 / 43 / 44 / 89 / 107	NE21, NE43
Channels	1 or 2*	1
Programming	5909 / HART 7 / HART 5	LOI / HART

APPROVALS:

ATEX	✓	✓
IECEX	✓	✓
FM	✓	✓
CSA	✓	✓
INMETRO	✓	✓
EU-RO marine	✓	✓
EAC Ex	✓	✓
NEPSI	✓	✓
SIL Hardware Assessment	✓	✓
SIL 2/3 Full Assessment IEC 61508	✓ / ✓	

APPLICATION GUIDE:

RTD / TC / mV input	✓ / ✓ / ✓	✓ / ✓ / ✓
Lin. R / potentiometer input	✓ / ✓	✓ / -
Dual input (4 terminals)		✓
True dual input (8 terminals)	✓	
Custom sensor linearization	✓	✓
mA output	✓	✓
Bus-powered PA/FF		
Loop-powered	✓	✓
Galvanically isolated	✓	✓
HART protocol	✓	✓
Process signal calibration	✓	✓

I.S. INTERFACES



TYPE	9106B	9107B	9113B	9116B
INPUT: mA, mV, V, potentiometer, RTD, Lin. R, TC, HART communication	HART transparent repeater	HART transparent driver	Temperature / mA converter	Universal converter
OUTPUT: mA, relays, HART communication				

INPUT:	9106B	9107B	9113B	9116B
mA, measurement range / min. span	3.5...23 mA / 16 mA	3.5 ...23 mA / 16 mA	0...23 mA / 16 mA	0...23 mA / 16 mA
V, measurement range / min. span				0...12 VDC / 0.8 V
RTD, measurement range / min. span			-200...+850°C / 25°C	-200...+850°C / 25°C
Lin. R, measurement range / min. span				0...10000 Ω / -10 Ω...10000 Ω
Potentiometer				
Sensor connection, wires			2 - 3 - 4	2 - 3 - 4
TC types			BEJLKNRSTUW3W5Lr	BEJLKNRSTUW3W5Lr
OUTPUT:				
mA, signal range / min. span	3.5...23 mA / 16 mA	3.5...23 mA / 16 mA	0...23 mA / 16 mA	0 ...23 mA / 16 mA
Relay				1 x SPST, AC: 500 VA
TECHNICAL SPECIFICATIONS:				
Ambient temperature	-20...+60°C	-20...+60°C	-20...+60°C	-20...+60°C
Supply voltage, DC	19.2...31.2 VDC	19.2...31.2 VDC	19.2...31.2 VDC	19.2...31.2 VDC
Max. required power, 1 / 2 channels	≤ 1.1 W / ≤ 1.9 W	≤ 1.0 W / ≤ 1.8 W	≤ 0.8 W / ≤ 1.4 W	≤ 2.1 W / -
Isolation voltage, test / operation	2.6 kVAC / 250 VAC	2.6 kVAC / 250 VAC	2.6 kVAC / 250 VAC	2.6 kVAC / 250 VAC
Response time	< 5 ms	< 5 ms	0.4 / 1...60 s	0.4 / 1...60 s
Signal dynamics, input / output	Analog signal chain	Analog signal chain	24 bit / 16 bit	24 bit / 16 bit
Accuracy	< ±16 µA	< ±16 µA	≤ ±0.1% of span	≤ ±0.1% of span
Temperature coefficient	< ±0.01% of span / °C	< ±0.01% of span / °C	< ±0.01% of span / °C	< ±0.01% of span / °C
NAMUR	NE21	NE21	NE21, NE43	NE21, NE43
Channels	1 or 2	1 or 2	1 or 2	1
Programming	4500 series devices	4500 series devices	4500 series devices	4500 series devices

APPROVALS:	9106B	9107B	9113B	9116B
ATEX	✓	✓	✓	✓
IECEx	✓	✓	✓	✓
FM	✓	✓	✓	✓
INMETRO	✓	✓	✓	✓
UL 61010 / 913	✓ / ✓	✓ / ✓	✓ / ✓	✓ / ✓
DNV	✓	✓	✓	✓
EAC Ex	✓	✓	✓	✓
SIL 2/3 Full Assessment IEC 61508	✓ / ✓	✓ / -	✓ / -	✓ / -
CCC	✓	✓	✓	✓

APPLICATION GUIDE:	9106B	9107B	9113B	9116B
AI barrier	✓		✓	✓
AO barrier		✓		
DI barrier				
DO barrier				
mA / V / temperature input	✓ / - / -	✓ / - / -	✓ / - / ✓	✓ / ✓ / ✓
4...20 mA Tx input	✓			✓
mA / V / relay output	✓ / - / -	✓ / - / -	✓ / - / -	✓ / - / ✓
Active / passive mA output	✓ / ✓	✓ / -	✓ / ✓	✓ / ✓
HART signal transparent	✓	✓		
Process signal calibration			✓	✓
Power rail option	✓	✓	✓	✓



TYPE	9202B	9203B			
INPUT: Hz	Pulse isolator	Solenoid / alarm driver			
OUTPUT: Pulse, relay					
INPUT: mA, measurement range / min. span V, measurement range / min. span RTD, measurement range / min. span Lin. R, measurement range / min. span Potentiometer Sensor connection, wires TC types Sensor type Hz, measurement range / min. span Min. pulse width	NAMUR / switch 0...5 kHz 100 µs	NPN / PNP / switch			
OUTPUT: mA, signal range / min. span Pulse output Hz, signal range Relay	NPN / relay 0...5 kHz 1 x SPST, AC: 500 VA	Valves etc.			
TECHNICAL SPECIFICATIONS: Ambient temperature Supply voltage, DC Max. required power, 1 / 2 channels Isolation voltage, test / operation Response time Signal dynamics, input / output Accuracy Temperature coefficient NAMUR Channels Programming	-20...+60°C 19.2...31.2 VDC ≤ 1.1...1.3 W / ≤ 1.5...1.9 W 2.6 kVAC / 250 VAC 200 ms NE21 1 or 2 4500 series devices	-20...+60°C 19.2...31.2 VDC ≤ 1.9...2.5 W / ≤ 3.1 W 2.6 kVAC / 250 VAC < 10 ms NE21 1 or 2 4500 series devices			
APPROVALS: ATEX IECEX FM INMETRO UL 61010 / 913 DNV EAC Ex SIL 2/3 Full Assessment IEC 61508 CCC	✓ ✓ ✓ ✓ ✓ / ✓ ✓ ✓ ✓ / - ✓	✓ ✓ ✓ ✓ ✓ / ✓ ✓ ✓ ✓ / - ✓			
APPLICATION GUIDE: AI barrier AO barrier DI barrier DO barrier mA / V / temperature input 4...20 mA Tx input mA / V / relay output Active / passive mA output HART signal transparent Process signal calibration Power rail option	✓ ✓	✓ ✓			

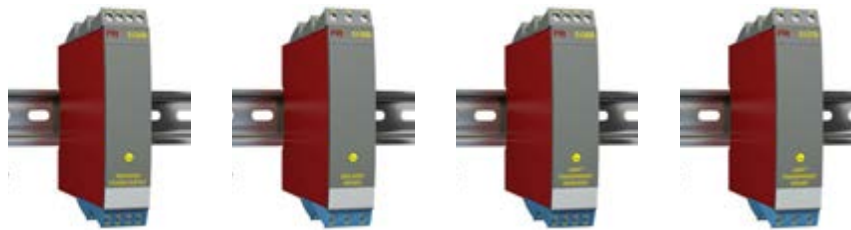

TYPE	5104B	5105B	5106B	5107B
------	-------	-------	-------	-------

INPUT:

mA, mV, V, potentiometer, RTD, linear resistance, TC, HART transparent

OUTPUT:

mA, V, relays, HART transparent

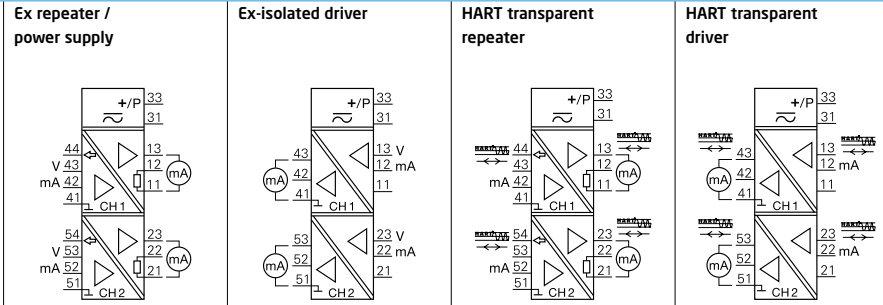

INPUT:

mA, measurement range / min. span	0...23 mA / 16 mA	0...23 mA / 16 mA	3.5...23 mA / 16 mA	3.5...23 mA / 16 mA
V, measurement range / min. span	0...10 VDC / 8 VDC	0...10 VDC / 8 VDC		
mV, measurement range / min. span				
RTD, measurement range / min. span				
Lin. R, measurement range / min. span				
Potentiometer				
Sensor connection, wires				
TC types				
Max. offset	20% of selec. max. value	20% of selec. max. value	20% of selec. max. value	20% of selec. max. value

OUTPUT:

mA, signal range / min. span	0...23 mA / 16 mA	0...23 mA / 16 mA	3.5...23 mA / 16 mA	3.5...23 mA / 16 mA
Load (@ current output)	≤ 600 Ω	≤ 770 Ω	≤ 600 Ω	≤ 770 Ω
V, signal range / min. span	0...10 VDC / 0.8 VDC	0...10 VDC / 0.8 VDC		
Max. offset	20% of selec. max. value	20% of selec. max. value	20% of selec. max. value	20% of selec. max. value

TECHNICAL SPECIFICATIONS:

Ambient temperature	-20...+60°C	-20...+60°C	-20...+60°C	-20...+60°C
Supply voltage, AC / DC	21.6...253V / 19.2...300V	21.6...253V / 19.2...300V	21.6...253V / 19.2...300V	21.6...253V / 19.2...300V
Max. required power, 1 / 2 channels	2.0 W / 2.8 W	1.3 W / 2.0 W	2.0 W / 2.8 W	1.4 W / 2.1 W
Isolation voltage, test / operation	3.75 kVAC / 250 VAC	3.75 kVAC / 250 VAC	3.75 kVAC / 250 VAC	3.75 kVAC / 250 VAC
Response time	< 25 ms	< 25 ms	< 25 ms	< 25 ms
Signal dynamics, input / output	Analog signal chain	Analog signal chain	Analog signal chain	Analog signal chain
Accuracy	≤ ±0.1% of span	≤ ±0.1% of span	≤ ±0.1% of span	≤ ±0.1% of span
Temperature coefficient	< ±0.01% of span / °C	< ±0.01% of span / °C	< ±0.01% of span / °C	< ±0.01% of span / °C
NAMUR	NE21	NE21	NE21	NE21
Channels	1 or 2	1 or 2	1 or 2	1 or 2
Programming	DIP switch	DIP Switch	No	No

APPROVALS:

ATEX	✓	✓	✓	✓
IECEx				
FM				
CSA				
UL	✓	✓	✓	✓
DNV	✓	✓	✓	✓
EAC Ex	✓	✓	✓	✓

APPLICATION GUIDE:

AI barrier	✓		✓	
AO barrier		✓		✓
DI barrier				
DO barrier				
RTD / TC input				
mA / V / mV input	✓ / ✓ / -	✓ / ✓ / -	✓ / - / -	✓ / - / -
4...20 mA Tx input	✓		✓	
Lin. R / potentiometer input				
mA / V / relay output	✓ / ✓ / -	✓ / ✓ / -	✓ / - / -	✓ / - / -
Active / passive mA output	✓ / ✓	✓ / -	✓ / ✓	✓ / -
Process signal calibration				

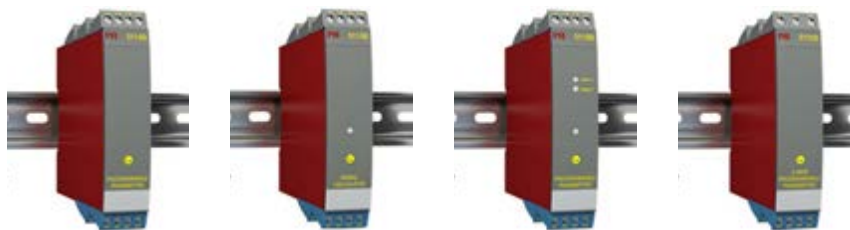

TYPE

5114B

5115B

5116B

5131B

INPUT:

mA, mV, V, potentiometer, RTD, linear resistance, TC

OUTPUT:

mA, V, relays,

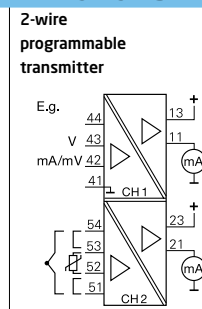
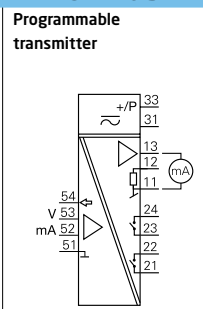
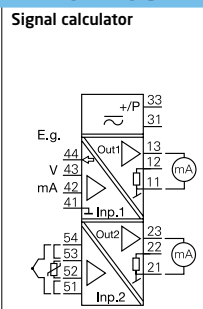
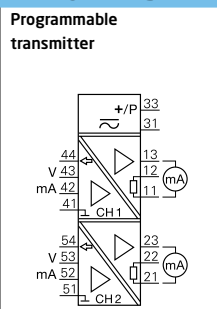

INPUT:

mA, measurement range / min. span	0...100 mA / 4 mA	0...100 mA / 4 mA	0...100 mA / 4 mA	0...100 mA / 4 mA
V, measurement range / min. span	0...250 VDC / 5 mV	0...250 VDC / 5 mV	0...250 VDC / 5 mV	0...250 VDC / 5 mV
mV, measurement range / min. span	-150...+150 mV / 5 mV	-150...+150 mV / 5 mV	-2500...+2500 mV / 5 mV	-150...+150 mV / 5 mV
RTD, measurement range / min. span	-200...+850°C / 25°C	-200...+850°C / 25°C	-200...+850°C / 25°C	-200...+850°C / 25°C
Lin. R, measurement range / min. span	0...5000 Ω / 30 Ω	0...5000 Ω / 30 Ω	0...5000 Ω / 30 Ω	0...5000 Ω / 30 Ω
Potentiometer	200 Ω...100 kΩ	200 Ω...100 kΩ	200 Ω...100 kΩ	200 Ω...100 kΩ
Sensor connection, wires	2 - 3 - 4	2 - 3 - 4	2 - 3 - 4	2 - 3 - 4
TC types	BEJKLNRSTUW3W5Lr	BEJKLNRSTUW3W5Lr	BEJKLNRSTUW3W5Lr	BEJKLNRSTUW3W5Lr
Max. offset	50% of selec. max. value	50% of selec. max. val.	50% of selec. max. val.	50% of selec. max. val.

OUTPUT:

mA, signal range / min. span	0...23 mA / 10 mA	0...23 mA / 10 mA	0...23 mA / 10 mA	3.5...23 mA / 10 mA
Load (@ current output)	600 Ω	600 Ω	600 Ω	600 Ω
V, signal range / min. span	0...10 VDC / 0.5 VDC	0...10 VDC / 0.5 VDC	0...10 VDC / 0.5 VDC	0...10 VDC / 0.5 VDC
Max. offset	50% of selec. max. value	50% of selec. max. val.	50% of selec. max. val.	50% of selec. max. val.
Relays			2 x SPST, AC: 500 VA	

TECHNICAL SPECIFICATIONS:

Ambient temperature	-20...+60°C	-20...+60°C	-20...+60°C	-20...+60°C
Supply voltage, AC / DC	21.6...253V / 19.2...300V	21.6...253V/19.2...300V	21.6...253 V / 19.2...300 V	- / 7.5...35 VDC
Max. required power, 1 / 2 channels	2.1 W / 2.8 W	2.1 W / 2.8 W	2.4 W / -	0.8 W / 1.6 W
Isolation voltage, test / operation	3.75 kVAC / 250 VAC	3.75 kVAC / 250 VAC	3.75 kVAC / 250 VAC	3.75 kVAC / 250 VAC
Response time	250 ms...60 s	250 ms...60 s	250 ms...60 s	250 ms...60 s
Signal dynamics, input / output	22 bit / 16 bit	22 bit / 16 bit	22 bit / 16 bit	22 bit / 16 bit
Accuracy	≤ ±0.05% of span	≤ ±0.05% of span	≤ ±0.05% of span	≤ ±0.05% of span
Temperature coefficient	< ±0.01% of span / °C	< ±0.01% of span / °C	< ±0.01% of span / °C	< ±0.01% of span / °C
NAMUR	NE21, NE43	NE21, NE43	NE21, NE43	NE21, NE43
Channels	1 or 2	2	1	1 or 2
Programming	5909 + DIP switch	5909 + DIP switch	5909	5909 + DIP switch

APPROVALS:

ATEX	✓	✓	✓	✓
IECEX				
FM				
CSA				
UL				
DNV	✓	✓	✓	✓
EAC Ex	✓	✓	✓	✓

APPLICATION GUIDE:

AI barrier	✓	✓	✓	✓
AO barrier				
DI barrier				
DO barrier				
RTD / TC input	✓ / ✓	✓ / ✓	✓	✓
mA / V / mV input	✓ / ✓ / ✓	✓ / ✓ / ✓	✓	✓
4...20 mA Tx input	✓	✓	✓	✓
Lin. R / potentiometer input	✓ / ✓	✓ / ✓	✓ / ✓	✓ / ✓
mA / V / relay output	✓ / ✓ / -	✓ / ✓ / -	✓	✓
Active / passive mA output	✓ / ✓	✓ / ✓	✓	✓
Process signal calibration	✓	✓		

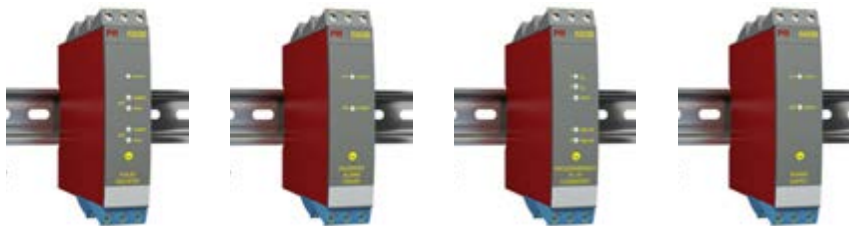

TYPE	5202B	5203B	5223B	5420B
	Pulse isolator	Ex solenoid / alarm driver	Programmable f/I - f/f converter	Ex power supply for 2-wire Tx
INPUT: Frequency, pulse				
OUTPUT: mA, V, pulse, relays				

INPUT:				
mA, measurement range / min. span				
V, measurement range / min. span				
mV, measurement range / min. span				
RTD, measurement range / min. span				
Lin. R, measurement range / min. span				
Potentiometer				
Sensor connection, wires				
TC types				
Sensor type	NAMUR / switch	NPN / PNP / switch	NAMUR / switch	
Hz, measurement range / min. span	0...5 kHz		0...20 kHz / 0.001 Hz	
OUTPUT:				
mA, signal range / min. span			0...23 mA / 5 mA	
V, signal range / min. span			0...10 VDC / 0.25 VDC	
Pulse output	NPN / relay	Valves etc.	NPN / PNP / relay	
Hz, signal range	0...5 kHz		0...1000 Hz	
Relays	2 x SPDT, AC: 100 VA		2 x SPST, AC: 100 VA	1 x SPDT, AC: 100 VA
Voltage / current				> 18 VDC / 20 mA
TECHNICAL SPECIFICATIONS:				
Ambient temperature	-20...+60°C	-20...+60°C	-20...+60°C	-20...+60°C
Supply voltage, AC / DC	21.6...253V / 19.2...300V	21.6...253V / 19.2...300V	21.6...253V / 19.2...300V	21.6...253V / 19.2...300V
Max. required power, 1 / 2 channels	- / 1.8 W	2.0 W / 2.5 W	3 W / -	- / 2.5 W
Isolation voltage, test / operation	3.75 kVAC / 250 VAC	3.75 kVAC / 250 VAC	3.75 kVAC / 250 VAC	3.75 kVAC / 250 VAC
Response time			60 ms...1000 s	
Signal dynamics, input / output			- / 16 bit	
Accuracy				
Temperature coefficient			< ±0.01% of span / °C	
NAMUR	NE21	NE21		NE21
Channels	2	1 or 2	1	2
Programming	DIP switch	DIP switch	5909 + DIP switch	No

APPROVALS:				
ATEX	✓	✓	✓	✓
IECEX				
FM				
CSA				
UL	✓	✓		
DNV				
EAC Ex	✓	✓	✓	✓
SIL 2, Hardware Assessment	✓			

APPLICATION GUIDE:				
AI barrier				
AO barrier				
DI barrier	✓		✓	
DO barrier		✓		
mA / V / temperature input				
4...20 mA Tx input				✓
mA / V / relay output				
Active / passive mA output			✓	
Process signal calibration				



TYPE	5531A	5531B1	5714	5715	5725
INPUT: RTD, TC, mV, mA, V, potentiometer, frequency, pulse	Loop-powered LCD indicator	Loop-powered LCD indicator in I.S. enclosure	Programmable LED indicator	Programmable LED indicator	Programmable frequency indicator
OUTPUT: Display, mA, relays					
INPUT:					
mA, measurement range / min. span	3.6...23 mA / 16 mA	3.6...23 mA / 16 mA	0...23 mA / 16 mA	0...23 mA / 16 mA	
V, measurement range / min. span			0...12 VDC / 0.8 V	0...12 VDC / 0.8 V	
Sensor type					All standard sensors □
Hz, measurement range / min. span					0...50 kHz / 0.001 Hz
Min. pulse width					25 μs
RTD, measurement range / min. span			-200...+850°C	-200...+850°C	
Lin. R, measurement range / min. span			0...10000 Ω / -	0...10000 Ω / -	
Potentiometer			10 Ω...100 kΩ	10 Ω...100 kΩ	
Sensor connection, wires			2 - 3 - 4	2 - 3 - 4	
TC types			BEJKNRSTUW3W5Lr	BEJKNRSTUW3W5Lr	
Cold junction compensation			Internal	Internal	
Reference voltage / 2-wire supply			- / >15 VDC	- / >15 VDC	
Sensor supply					5...17 VDC
OUTPUT:					
Display, digit / type	4-digit / LCD	4-digit / LCD	4-digit / LED	4-digit / LED	4-digit / LED
Display, digit height	16 mm	16 mm	13.8 mm	13.8 mm	13.8 mm
mA, signal range / min. span			0...23 mA / 16 mA	0...23 mA / 16 mA	0...23 mA / 16 mA
Relay			2 x SPDT, AC: 500 VA	4 x SPDT, AC: 500 VA	2 x SPDT, AC: 500 VA
TECHNICAL SPECIFICATIONS:					
Ambient temperature	-20...+60°C	-20...+60°C	-20...+60°C	-20...+60°C	-20...+60°C
Supply voltage, universal AC / DC	- / 1.5 VDC	- / 1.5 VDC	21.6...253V / 19.2...300V	21.6...253V / 19.2...300V	21.6...253V / 19.2...300V
Max. required power	<35 mW	<35 mW	3.5 W	3.8 W	3.6 W
Isolation voltage, test / operation			2.3 kVAC / 250 VAC	2.3 kVAC / 250 VAC	2.3 kVAC / 250 VAC
Response time	< 1 s	< 1 s	< 400 ms / < 1 s	< 400 ms / < 1 s	1...60 s
Accuracy	≤ ±0.1% of span	≤ ±0.1% of span	≤ ±0.1% of reading	≤ ±0.1% of reading	≤ ±0.1% of reading
Temperature coefficient	< ±0.01% of span / °C	< ±0.01% of span / °C	≤ ±0.01% of reading / °C	≤ ±0.01% of reading / °C	≤ ±0.01% of reading / °C
NAMUR			NE43	NE43	NE43
Programming	Switch / front keys	Switch / front keys	Front keys	5909 / front keys	Front keys
APPROVALS:					
ATEX, Zone 2	✓	✓			
UL 508			✓	✓	✓
DNV EU-RO marine			✓	✓	✓
EAC	✓	✓	✓	✓	✓
APPLICATION GUIDE:					
mA / V / mV input	✓ / - / -	✓ / - / -	✓ / ✓ / -	✓ / ✓ / -	
Temperature input			✓	✓	
Lin. R / potentiometer input			✓ / ✓	✓ / ✓	
Frequency input					✓
Custom sensor linearization				✓	
4...20 mA Tx input			✓	✓	
Loop-powered	✓	✓			
mA output			✓	✓	✓
2 / 4 relay outputs			✓ / -	- / ✓	✓ / -
Process signal calibration	✓	✓	✓	✓	✓
Mounting in Zone 2	✓	✓			

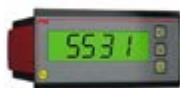

TYPE	5531B	5531B2			
INPUT: mA	Loop-powered LCD indicator	Loop-powered LCD indicator in I.S. enclosure			
OUTPUT: Display					

INPUT:					
mA, measurement range / min. span	3.6...23 mA / 16 mA	3.6...23 mA / 16 mA			
OUTPUT:					
Display, digit / type	4-digit / LCD	4-digit / LCD			
Display, digit height	16 mm	16 mm			
TECHNICAL SPECIFICATIONS:					
Ambient temperature	-20...+60°C	-20...+60°C			
Supply voltage, universal AC / DC	- / 1.5 VDC	- / 1.5 VDC			
Max. required power	<35 mW	<35 mW			
Isolation voltage, test / operation					
Response time	< 1 s	< 1 s			
Accuracy	≤ ±0.1% of span	≤ ±0.1% of span			
Temperature coefficient	< ±0.01% of span / °C	< ±0.01% of span / °C			
NAMUR					
Programming	Switch / front keys	Switch / front keys			

APPROVALS:					
ATEX	✓	✓			
DNV					
EAC Ex	✓	✓			

APPLICATION GUIDE:					
Loop-powered	✓	✓			
Mounting in ZoNE1 / Z1	✓	✓			
Field enclosure		✓			

POWER SUPPLIES

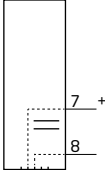
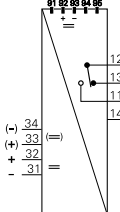
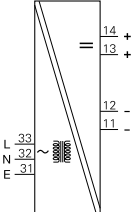

TYPE	3405	9410	9421		
INPUT: AC, DC voltage OUTPUT: Stabilized VDC	Power connector unit 	Power control unit 	Power supply 		
INPUT:					
Supply voltage, AC			85...132 VAC or 187...264 VAC		
Supply voltage, DC	16.8...31.2 VDC	21.6...26.4 VDC			
Supply voltage, back-up		21.6...26.4 VDC			
OUTPUT:					
Voltage	16.8...31.2 VDC	21.6...26.4 VDC	24 VDC		
Current		4 ADC	4.8 ADC		
Power, max.		96 W	115 W		
Status relay		1 x SPDT, AC: 500 VA			
TECHNICAL SPECIFICATIONS:					
Ambient temperature	-25...+70°C	-20...+60°C	-20...+60°C		
Max. required power		96 W	< 135 W		
Isolation, test		2.6 kVAC	4.3 kVAC		
Short circuit protection	No	Yes	Yes		
Output ripple	Same as input	Same as input	200 mV peak / peak		
Channels	1	1	1		
Programming	No	No	No		
APPROVALS:					
ATEX, Zone 2	✓	✓	✓		
IECEX, Zone 2	✓	✓			
UKEX, Zone 2	✓				
CSA, Zone 2 - DIV 2			✓		
FM, Zone 2 - DIV 2	✓	✓			
UL 61010 / 508 / 913	✓ / - / -	✓ / - / ✓	- / ✓ / - / -		
DNV	✓	✓			
EAC	✓	✓	✓		
INMETRO, Zone 2		✓			
CCC		✓			
APPLICATION GUIDE:					
115 / 230 VAC mains supply			✓		
24 VDC output			✓		
60 W power rail connector unit	✓				
96 W power rail connector unit		✓			
Redundancy power rail function		✓			
Collective status signal monitor		✓			
Internal fuse		✓	✓		
Mounting in Zone 2 / Div 2	✓	✓	✓		



TYPE	2224	2231	2261			
INPUT, DC: mA, V, potentiometer, frequency, pulse, joystick, load cell, mV						
INPUT, AC: A, V						
OUTPUT: mA, V, relays						
INPUT:						
mA, DC measurement range / min. span	0...20 mA / 16 mA	0...20 mA / 10 mA				
V, DC measurement range / min. span	-10...+10 VDC / 0.8 VDC	0...250 VDC / 0.5 VDC	-40...+100 mV / 10 mV			
A, AC measurement range / min. span		0...1 ARMS / 0.5 ARMS				
V, AC measurement range / min. span		0...250 VRMS/0.5 VRMS				
Potentiometer	> 1 kΩ					
Digital input	3 x PNP		1 x NPN / 1 x PNP			
Max. offset	20% of selec. max. value		70% of selec. max. value			
Excitation / reference voltage	- / -10...+10 VDC		5...13 VDC / -			
OUTPUT:						
mA, signal range / min. span	3000 mA		0...20 mA / 5 mA			
V, signal range / min. span	Supply-0.5 VDC		0...10 VDC / 0.25 VDC			
Max. offset			50% of selec. max. value			
Relays		2 x SPST, AC: 500 VA				
Display, digit / type	3-digit / LED	3-digit / LED	3-digit / LED			
TECHNICAL SPECIFICATIONS:						
Ambient temperature	-20...+60°C	-20...+60°C	-20...+60°C			
Supply voltage, universal AC / DC		21.6...253V / 19.2...300V				
Supply voltage, DC	12 or 24 VDC	19.2...28.8 VDC	19.2...28.8 VDC			
Max. required power	2.2 W	1.5 W DC / 2 W, UNI	2.2 W / max. 7.2 W			
Isolation voltage, test / operation		3.75 kVAC / 250 VAC				
Response time	< 75 ms	250 ms...60 s	60 ms...999 s			
Signal dynamics, input / output	12 bit / -	16 bit / -	17 bit / 16 bit			
Setpoint adjustment / repetition		0.1% / 0.1%				
Delay / hysteresis		0...99.9 s / 0...99.9%				
Temperature coefficient	< ±0.01% of span / °C	< ±0.01% of span / °C	< ±0.01% of span / °C			
Channels	1 or 2 outputs	1 input, 2 relays	1			
Programming	Switch / front keys	Switch / front keys	Switch / front keys			
APPROVALS:						
DNV		✓				
EAC	✓	✓	✓			
APPLICATION GUIDE:						
mA / V / mV input	✓ / ✓ / -	✓ / ✓ / -	- / - / ✓			
AC signal input		✓				
Digital ON/OFF signal input	✓		✓			
Controller / regulator function	✓	✓				
Load cell applications			✓			
Proportional valve applications	✓					
Frequency / pulse applications						
mA / V output			✓			
Relay output		✓				



TYPE 2255

INPUT, DC:
Frequency, pulse
INPUT, AC:
A, V
OUTPUT:
mA, V, relays, pulse

f/I - f/f converter

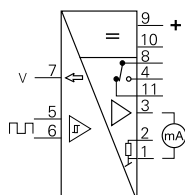

INPUT: PV / SP					
A, AC measurement range / min. span					
V, AC measurement range / min. span					
Max. offset					
Sensor type	All standard sensors □				
Hz, measurement range / min. span	0...20 kHz / 0.001 Hz				
Min. pulse width	25 μs				
Sensor supply	5...15 VDC				
OUTPUT:					
mA, signal range / min. span	0...20 mA / 5 mA				
V, signal range / min. span	0...10 VDC / 0.25 VDC				
Max. offset	50% of selec. max. value				
Load (@ current output)	≤ 600 Ω				
Pulse output	NPN				
Max. output frequency	1000 Hz				
Relays	1 x SPDT, AC: 300 VA				
Display, digit / type	3-digit / LED				
TECHNICAL SPECIFICATIONS:					
Ambient temperature	-20...+60°C				
Supply voltage, universal AC / DC					
Supply voltage, DC	19.2...28.8 VDC				
Max. required power	2.4 W				
Isolation voltage, test / operation	1.4 kVAC / 150 VAC				
Response time	60 ms...999 s				
Signal dynamics, input / output	- / 16 bit				
Accuracy					
Temperature coefficient	< ±0.01% of span / °C				
Channels	1				
Programming	Switch / front keys				

APPROVALS:					
EAC	✓				

APPLICATION GUIDE:					
Frequency / pulse applications	✓				
mA / V output	✓				
Relay output	✓				

A user-friendly and reliable mounting solution between the *DCS/PLC/SIS system and isolators/I.S. interfaces*

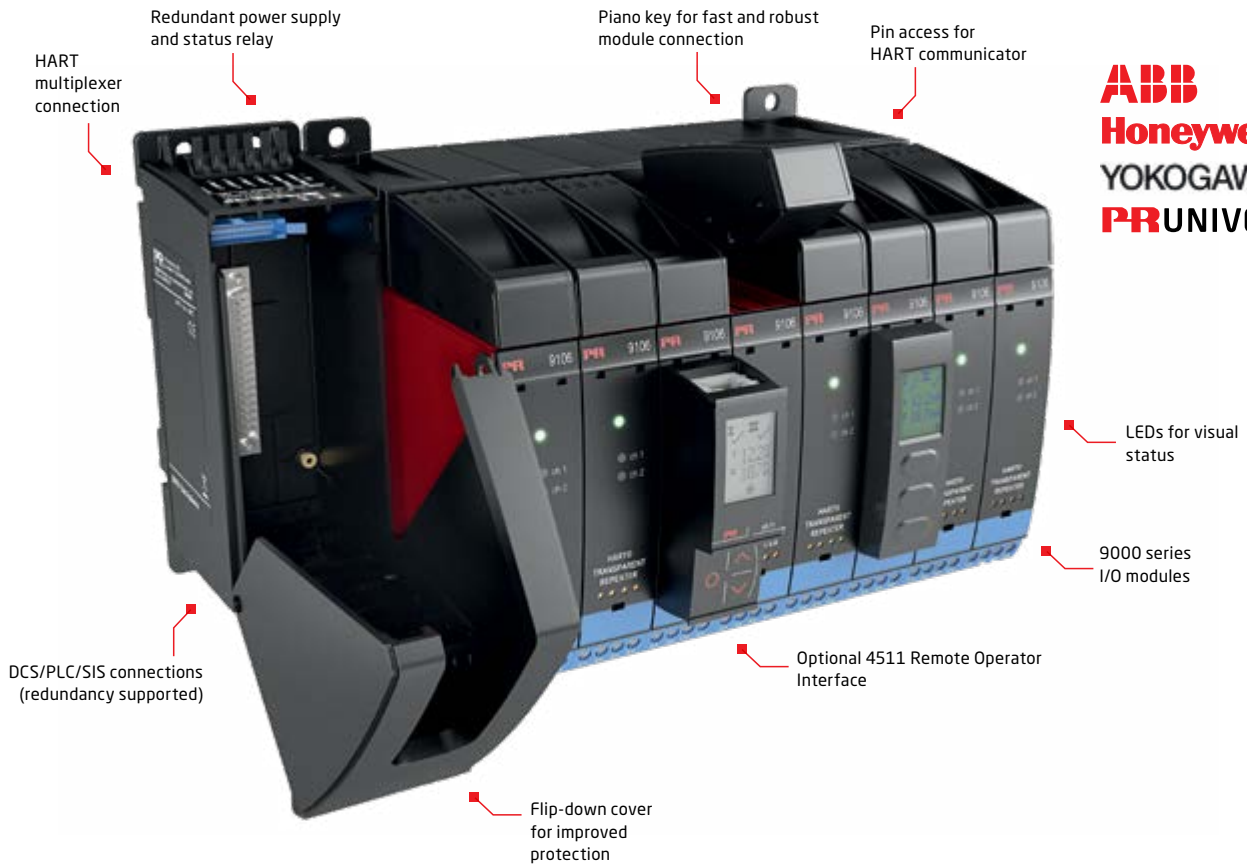

SIGNAL TYPES

INPUT

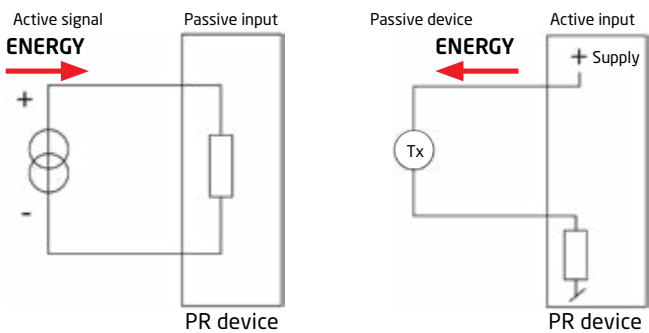

OUTPUT

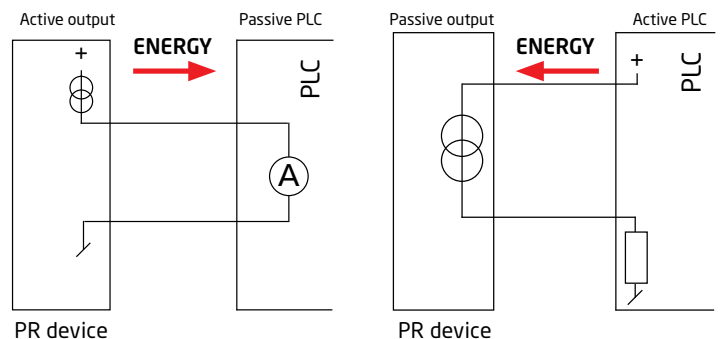

4510

Display / programming front



4511

Modbus communication enabler



4512

Bluetooth communication enabler with data logging



4590

ConfigMate



SOFTWARE

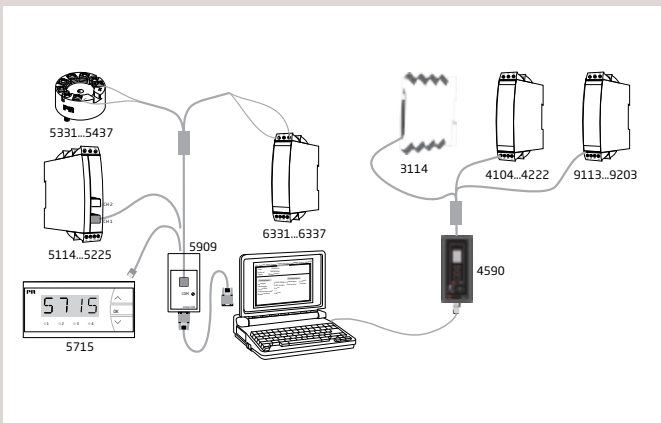

PRreset

PRreset is an easy-to-use menu-driven software program for set-up of PR products via a standard PC and a programming interface. PRreset gives a high degree of flexibility for each product and when the menus are completed, the data is transmitted to the unit which is then ready for operation.

Loop Link 5909

Loop Link 5909 is a USB communications interface for configuration and monitoring of PR electronics' PC-programmable devices. PR devices available in the configuration program PRreset ver. 5.0 or higher, can be programmed by way of Loop Link 5909.

277USB

USB HART modem



278

Bluetooth Low Energy (BLE) HART modem



3400T

Electromechanical counter



5909

Loop Link communications interface



5910

CJC connector, channel 1



5910Ex

CJC connector for I.S. / Ex devices, channel 1



5913

CJC connector, channel 2



5913Ex

CJC connector for I.S. / Ex devices, channel 2



7002

Spring clip



7005

Shunt resistor 0.1 Ω



7006

Shunt resistor 1 Ω



7007

2-digit digital potentiometer



7008

3-digit digital potentiometer



7009

10-turn potentiometer, 200 Ω



7010

10-turn potentiometer, 20 k Ω



7011

Dial for 10-turn potentiometer



7012

1-turn potentiometer, 1 k Ω



7014

Shunt resistor 0.5 Ω



7015

1-turn potentiometer, 10 k Ω



7016

1-turn potentiometer, 100 k Ω



7020

Knob for 1-turn potentiometer



7020A

Knob for 10-turn potentiometer



7023

11-pole relay socket



7024

Code ring and code pin



7028

10-turn potentiometer, 2 kΩ



7029

Shunt resistor 0.2 Ω



7030

Shunt resistor 0.1 Ω for DIN rail mounting



7031

Label sheet with engineering units



7400

Pt100 temperature sensor



7410C

Pt100 temperature sensor



7423

Ceramic socket for Pt100 sensor



7430B

Pt100 cable sensor, Ø6 x 60 mm



7430C

Pt100 cable sensor, Ø5 x 20 mm



7440

Thermowell for 7400 Pt100 sensor



8201L

Power wire, supply pin 31+33, left



8201R

Power wire, supply pin 31+33, right



8202L

Power wire, supply pin 31+32, left



8202R

Power wire, supply pin 31+32, right

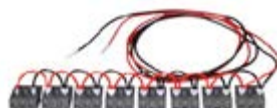

8335

Splash-proof cover



8341

Inductive proximity sensor, NAMUR



8342

Inductive proximity sensor, NAMUR



8343

Inductive proximity sensor, NPN



8344

Inductive proximity sensor, NPN



8421

DIN rail fitting



8501

Field enclosure



8509

M12 interface cable for 5909 Loop Link



8510

8 unit 4511 Modbus cable



8511

4511 Y-splitter Modbus cable



8513

RJ45 Modbus termination



8514

3 X RJ45 female Y-splitter



8515

RJ45 female to female cable adapter



8516

RJ45 female to female shielded cable adapter



8517

3 x RJ45 female shielded Y-splitter



8550

7501 M20 plug with silicoNEO-ring for alu enclosure



8550-F

7501 M20 plug with FKM O-ring for alu enclosure



8550-S

7501 M20 plug with silicoNEO-ring for stainless steel enclosure



8550-SF

7501 M20 plug with FKM O-ring for stainless steel enclosure



8551

7501 1/2"NPT plug for alu enclosure



8551-S

7501 1/2"NPT plug for stainless steel enclosure



8552

Pipe-mounting bracket for 7501



8555

Display with LOI for 7501



8556

Display without LOI for 7501



8557

Bracket spare part for display and transmitter (for 7501)



8558

Bracket spare part for transmitter only (for 7501)



9400_1

Power rail 15 mm profile



9400_2

Power rail 7.5 mm profile



9402

Extra end covers for power rail



9404

Module stop for rail



POWER RAIL

The data sheet specifies the maximum required power at nominal operating values, e.g. 24 V supply voltage, 60°C ambient temperature, 600 Ω load, and 20 mA output current.

In typical applications, the devices are not running at worst-case conditions, specifically when many devices are located together. For engineering purposes, 70% (P70%) of maximum required power is often used.

3000 power rail

The number* of 3000 devices that can be powered from different power sources is listed in the table below:

	Using a PR converter device as power feed-in	3405 power feed-in	9410 power feed-in
P70%	Up to 21 devices	Up to 131 devices	Up to 210 devices
P100%	Up to 14 devices	Up to 92 devices	Up to 147 devices

The devices can be stacked vertically or horizontally.

* The number of devices is based on the PR 3103 which has the lowest power consumption of the 3000 series power rail devices.

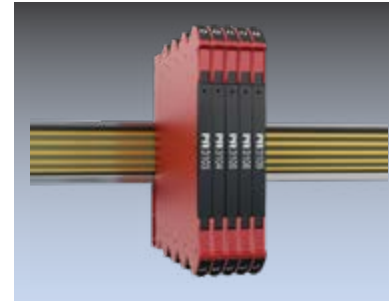

9000 power rail

The number of 9000 devices that can be powered from the 9400 power sources is listed in the table below:

	9410 power feed-in
P70%	Up to 150 devices
P100%	Up to 120 devices



ENVIRONMENTAL SPECIFICATIONS

	PR 2200 series	PR 3000 series	PR 4000 series	PR 5000 series	PR 5300 series
Specifications range	-20°C to +60°C	-25°C to +70°C (3105: 0°C to +70°C)	-20°C to +60°C	-20°C to +60°C	-40°C to +85°C
Relative humidity	< 95% RH (non-cond.)	< 95% RH (non-cond.)	< 95% RH (non-cond.)	< 95% RH (non-cond.)	< 95% RH (non-cond.)
Protection degree	IP50	IP20	IP20	IP20	IP68 / IP00
	PR 5400 series	PR 5500 / 5700 series	PR 6300 series	PR 7500 series	PR 9000 series
Specifications range	-50°C to +85°C	-20°C to +60°C	-40°C to +85°C	-20 / -40°C to +85°C	-20°C to +60°C
Relative humidity	< 99% RH (non-cond.)	< 95% RH (non-cond.)	< 95% RH (non-cond.)	0..100% RH (cond.)	< 95% RH (non-cond.)
Protection degree	IP68 / IP00	IP65 from front (5500) IP65 / Type 4X, UL50E	IP20	IP54 / IP66 / IP68 / type 4X	IP20

ENCLOSURE SPECIFICATIONS

Dimensions (mm)	Height	Width	Depth	Panel cut-out	Material
PR 2200 series	80.5	35.5	84.5+socket		Cycology/Noryl
PR 3000 series	113	6.1	115		Cycology
PR 4000 / 6000 / 9000 series	109	23.5	104		Cycology
PR 4500 series	73.2	23.3	26.5		Cycology
PR 5000 series	109	23.5	130		Cycology
PR 5300 series	20.2	Ø44			Cycology
PR 5400 series	21.45	Ø44			Cycology
PR 5500 / 5700 series	48	96	120	44.5 x 91.5	Noryl
PR 7500 series	109	145	125.5		Aluminum

Benefit today from *PERFORMANCE MADE SMARTER*

PR electronics is the leading technology company specialized in making industrial process control safer, more reliable and more efficient. Since 1974, we have been dedicated to perfecting our core competence of innovating high precision technology with low power consumption. This dedication continues to set new standards for products communicating, monitoring and connecting our customers' process measurement points to their process control systems.

Our innovative, patented technologies are derived from our expansive R&D facilities and from having a great understanding of our customers' needs and processes. We are guided by principles of simplicity, focus, courage and excellence, enabling some of the world's greatest companies to achieve PERFORMANCE MADE SMARTER.

10ISEN-W20 (2242)

